

PHILIPPINE BIDDING DOCUMENTS

ITB 2023-12-094 CONSTRUCTION OF SKILLS TRAINING CENTER FOR BREAD AND PASTRIES AND WATER REFILLING STATION AT DSWD FOIX RRCY, POLANCO, ZDN

Government of the Republic of the Philippines

**Sixth Edition
July 2020**

Preface

These Philippine Bidding Documents (PBDs) for the procurement of Infrastructure Projects (hereinafter referred to also as the “Works”) through Competitive Bidding have been prepared by the Government of the Philippines for use by all branches, agencies, departments, bureaus, offices, or instrumentalities of the government, including government-owned and/or -controlled corporations, government financial institutions, state universities and colleges, local government units, and autonomous regional government. The procedures and practices presented in this document have been developed through broad experience, and are for mandatory use in projects that are financed in whole or in part by the Government of the Philippines or any foreign government/foreign or international financing institution in accordance with the provisions of the 2016 revised Implementing Rules and Regulations (IRR) of Republic Act (RA) No. 9184.

The PBDs are intended as a model for admeasurements (unit prices or unit rates in a bill of quantities) types of contract, which are the most common in Works contracting.

The Bidding Documents shall clearly and adequately define, among others: (i) the objectives, scope, and expected outputs and/or results of the proposed contract; (ii) the eligibility requirements of Bidders; (iii) the expected contract duration; and (iv) the obligations, duties, and/or functions of the winning Bidder.

Care should be taken to check the relevance of the provisions of the PBDs against the requirements of the specific Works to be procured. If duplication of a subject is inevitable in other sections of the document prepared by the Procuring Entity, care must be exercised to avoid contradictions between clauses dealing with the same matter.

Moreover, each section is prepared with notes intended only as information for the Procuring Entity or the person drafting the Bidding Documents. They shall not be included in the final documents. The following general directions should be observed when using the documents:

- a. All the documents listed in the Table of Contents are normally required for the procurement of Infrastructure Projects. However, they should be adapted as necessary to the circumstances of the particular Project.
- b. Specific details, such as the “*name of the Procuring Entity*” and “*address for bid submission*,” should be furnished in the Instructions to Bidders, Bid Data Sheet, and Special Conditions of Contract. The final documents should contain neither blank spaces nor options.
- c. This Preface and the footnotes or notes in italics included in the Invitation to Bid, BDS, General Conditions of Contract, Special Conditions of Contract, Specifications, Drawings, and Bill of Quantities are not part of the text of the final document, although they contain instructions that the Procuring Entity should strictly follow.
- d. The cover should be modified as required to identify the Bidding Documents as to the names of the Project, Contract, and Procuring Entity, in addition to date of issue.

- e. Modifications for specific Procurement Project details should be provided in the Special Conditions of Contract as amendments to the Conditions of Contract. For easy completion, whenever reference has to be made to specific clauses in the Bid Data Sheet or Special Conditions of Contract, these terms shall be printed in bold typeface on Sections I (Instructions to Bidders) and III (General Conditions of Contract), respectively.
- f. For guidelines on the use of Bidding Forms and the procurement of Foreign-Assisted Projects, these will be covered by a separate issuance of the Government Procurement Policy Board.

TABLE OF CONTENTS

Glossary of Terms, Abbreviations, and Acronyms	5
Section I. Invitation to Bid	8
Section II. Instructions to Bidders	11
1. Scope of Bid	12
2. Funding Information	12
3. Bidding Requirements	12
4. Corrupt, Fraudulent, Collusive, Coercive, and Obstructive Practices	13
5. Eligible Bidders	13
6. Origin of Associated Goods	13
7. Subcontracts	13
8. Pre-Bid Conference	14
9. Clarification and Amendment of Bidding Documents	14
10. Documents Comprising the Bid: Eligibility and Technical Components	14
11. Documents Comprising the Bid: Financial Component	15
12. Alternative Bids	15
13. Bid Prices	15
14. Bid and Payment Currencies	16
15. Bid Security	16
16. Sealing and Marking of Bids	16
17. Deadline for Submission of Bids	16
18. Opening and Preliminary Examination of Bids	17
19. Detailed Evaluation and Comparison of Bids	17
20. Post Qualification	17
21. Signing of the Contract	17
Section III. Bid Data Sheet	18
Section IV. General Conditions of Contract	20
1. Scope of Contract	21
2. Sectional Completion of Works	21
3. Possession of Site	21
4. The Contractor's Obligations	21
5. Performance Security	22
6. Site Investigation Reports	22

7.	Warranty	22
8.	Liability of the Contractor	22
9.	Termination for Other Causes	22
10.	Dayworks	23
11.	Program of Work	23
12.	Instructions, Inspections and Audits	23
13.	Advance Payment	23
14.	Progress Payments	23
15.	Operating and Maintenance Manuals	23
Section V. Special Conditions of Contract		25
Section VI. Specifications		28
Section VII. Drawings		30
Section VIII. Bill of Quantities		31
Section IX. Checklist of Technical and Financial Documents		33

Glossary of Terms, Abbreviations, and Acronyms

ABC – Approved Budget for the Contract.

ARCC – Allowable Range of Contract Cost.

BAC – Bids and Awards Committee.

Bid – A signed offer or proposal to undertake a contract submitted by a bidder in response to and in consonance with the requirements of the bidding documents. Also referred to as *Proposal* and *Tender*. (2016 revised IRR, Section 5[c])

Bidder – Refers to a contractor, manufacturer, supplier, distributor and/or consultant who submits a bid in response to the requirements of the Bidding Documents. (2016 revised IRR, Section 5[d])

Bidding Documents – The documents issued by the Procuring Entity as the bases for bids, furnishing all information necessary for a prospective bidder to prepare a bid for the Goods, Infrastructure Projects, and/or Consulting Services required by the Procuring Entity. (2016 revised IRR, Section 5[e])

BIR – Bureau of Internal Revenue.

BSP – Bangko Sentral ng Pilipinas.

CDA – Cooperative Development Authority.

Consulting Services – Refer to services for Infrastructure Projects and other types of projects or activities of the GOP requiring adequate external technical and professional expertise that are beyond the capability and/or capacity of the GOP to undertake such as, but not limited to: (i) advisory and review services; (ii) pre-investment or feasibility studies; (iii) design; (iv) construction supervision; (v) management and related services; and (vi) other technical services or special studies. (2016 revised IRR, Section 5[i])

Contract – Refers to the agreement entered into between the Procuring Entity and the Supplier or Manufacturer or Distributor or Service Provider for procurement of Goods and Services; Contractor for Procurement of Infrastructure Projects; or Consultant or Consulting Firm for Procurement of Consulting Services; as the case may be, as recorded in the Contract Form signed by the parties, including all attachments and appendices thereto and all documents incorporated by reference therein.

Contractor – is a natural or juridical entity whose proposal was accepted by the Procuring Entity and to whom the Contract to execute the Work was awarded. Contractor as used in these Bidding Documents may likewise refer to a supplier, distributor, manufacturer, or consultant.

CPI – Consumer Price Index.

DOLE – Department of Labor and Employment.

DTI – Department of Trade and Industry.

Foreign-funded Procurement or Foreign-Assisted Project – Refers to procurement whose funding source is from a foreign government, foreign or international financing institution as specified in the Treaty or International or Executive Agreement. (2016 revised IRR, Section 5[b]).

GFI – Government Financial Institution.

GOCC – Government-owned and/or –controlled corporation.

Goods – Refer to all items, supplies, materials and general support services, except Consulting Services and Infrastructure Projects, which may be needed in the transaction of public businesses or in the pursuit of any government undertaking, project or activity, whether in the nature of equipment, furniture, stationery, materials for construction, or personal property of any kind, including non-personal or contractual services such as the repair and maintenance of equipment and furniture, as well as trucking, hauling, janitorial, security, and related or analogous services, as well as procurement of materials and supplies provided by the Procuring Entity for such services. The term “related” or “analogous services” shall include, but is not limited to, lease or purchase of office space, media advertisements, health maintenance services, and other services essential to the operation of the Procuring Entity. (2016 revised IRR, Section 5[r])

GOP – Government of the Philippines.

Infrastructure Projects – Include the construction, improvement, rehabilitation, demolition, repair, restoration or maintenance of roads and bridges, railways, airports, seaports, communication facilities, civil works components of information technology projects, irrigation, flood control and drainage, water supply, sanitation, sewerage and solid waste management systems, shore protection, energy/power and electrification facilities, national buildings, school buildings, hospital buildings, and other related construction projects of the government. Also referred to as *civil works or works*. (2016 revised IRR, Section 5[u])

LGUs – Local Government Units.

NFCC – Net Financial Contracting Capacity.

NGA – National Government Agency.

PCAB – Philippine Contractors Accreditation Board.

PhilGEPS - Philippine Government Electronic Procurement System.

Procurement Project – refers to a specific or identified procurement covering goods, infrastructure project or consulting services. A Procurement Project shall be described, detailed, and scheduled in the Project Procurement Management Plan prepared by the agency which shall be consolidated in the procuring entity's Annual Procurement Plan. (GPPB Circular No. 06-2019 dated 17 July 2019)

PSA – Philippine Statistics Authority.

SEC – Securities and Exchange Commission.

SLCC – Single Largest Completed Contract.

UN – United Nations.

Section I. Invitation to Bid

Notes on the Invitation to Bid

The Invitation to Bid (IB) provides information that enables potential Bidders to decide whether to participate in the procurement at hand. The IB shall be posted in accordance with Section 21.2 of the 2016 revised IRR of RA No. 9184.

Apart from the essential items listed in the Bidding Documents, the IB should also indicate the following:

- a. The date of availability of the Bidding Documents, which shall be from the time the IB is first advertised/posted until the deadline for the submission and receipt of bids;
- b. The place where the Bidding Documents may be acquired or the website where it may be downloaded;
- c. The deadline for the submission and receipt of bids; and
- d. Any important bid evaluation criteria.

The IB should be incorporated into the Bidding Documents. The information contained in the IB must conform to the Bidding Documents and in particular to the relevant information in the Bid Data Sheet.



Invitation to Bid for the Construction of Skills Training Center for Bread and Pastries and Water Refilling Station at DSWD FOIX RRCY, Polanco, ZDN ITB 2023-12-094

1. The **Department of Social Welfare and Development (DSWD) Field Office IX**, through the NGA, the **General Appropriations Act 2023** intends to apply the sum of **FIVE MILLION, SIX HUNDRED SIXTY-NINE THOUSAND, ONE HUNDRED SIXTY-ONE PESO(S) AND FIFTY-EIGHT HUNDREDTH(S) (Php ₱5,669,161.58)** being the ABC to payments under the contract for the **Construction of Skills Training Center for Bread and Pastries and Water Refilling Station at DSWD FOIX RRCY, Polanco, ZDN ITB 2023-12-094**. Bids received in excess of the ABC shall be automatically rejected at bid opening.
2. The **Department of Social Welfare and Development (DSWD) Field Office IX** now invites bids for the above Procurement Project. Delivery of the Goods is required by (*please see Schedule of Deliveries in Section VI. Schedule of Requirements*). Bidders should have completed, within **ten (10) calendar years** from the date of submission and receipt of bids, a contract similar to the Project. The description of an eligible bidder is contained in the Bidding Documents, particularly, in Section II (Instructions to Bidders).
3. Bidding will be conducted through open competitive bidding procedures using non-discretionary “*pass/fail*” criterion as specified in the 2016 revised Implementing Rules and Regulations (IRR) of Republic Act (RA) No. 9184.
 - a. Bidding is restricted to Filipino citizens/sole proprietorships, partnerships, or organizations with at least sixty percent (60%) interest or outstanding capital stock belonging to citizens of the Philippines, and to citizens or organizations of a country the laws or regulations of which grant similar rights or privileges to Filipino citizens, pursuant to RA No. 5183.
4. Prospective Bidders may obtain further information from **Department of Social Welfare and Development (DSWD) Field Office IX** and inspect the Bidding Documents at the address given below during **office hours (8:00 AM to 5:00 PM, Mondays to Fridays)**.
5. A complete set of Bidding Documents may be acquired by interested Bidders on Saturday, December 9, 2023 from the given address and website(s) below and upon payment of the applicable fee for the Bidding Documents, pursuant to the latest Guidelines issued by the GPPB, in the amount of **10,000.00**. The Procuring Entity

shall allow the bidder to present its proof of payment for the fees in person, by facsimile, or through electronic means

4. The Department of Social Welfare and Development (DSWD) Field Office IX will hold a **Pre-Bid Conference¹ on 9:30 AM, Sunday, December 17, 2023 at **DSWD Field Office IX, Zamboanga City and/or through video conferencing or webcasting via Google meet.google.com/** which shall be opened to prospective bidders. All interested parties are required to send their email address to bac.dswdfo9@gmail.com for the provision of the meeting link.**
5. Bids must be duly received by the BAC Secretariat through manual submission at the office address indicated below, **on or before 9:00 AM, Friday, December 29, 2023.** Late bids shall not be accepted.
6. All Bids must be accompanied by a bid security in any of the acceptable forms and in the amount stated in ITB Clause 14.
7. Bid opening shall be **on or before 9:30 AM, Friday, December 29, 2023** at the given address below and/or via Google Meet. Bids will be opened in the presence of the bidders' representatives who choose to attend the activity.
8. The **Department of Social Welfare and Development (DSWD) Field Office IX** reserves the right to reject any and all bids, declare a failure of bidding, or not award the contract at any time prior to contract award in accordance with Sections 35.6 and 41 of the 2016 revised IRR of RA No. 9184, without thereby incurring any liability to the affected bidder or bidders.
9. For further information, please refer to:

MA. CORAZON G. SUMICAD
Chairperson Bids and Awards Committee
Department of Social Welfare and Development (DSWD) Field Office IX
General Vicente Alvarez St., Zamboanga City
bac.fo9@dswd.gov.ph
Tel. No. (062) 991-6030
<https://fo9.dswd.gov.ph/>

10. You may visit the following websites:
For downloading of Bidding Documents:
<https://fo9.dswd.gov.ph/procurement-advisory/procurement/public-bidding-2023>
-2/

MA. CORAZON G. SUMICAD
Chairperson, Bids and Awards Committee

¹ May be deleted in case the ABC is less than One Million Pesos (PhP1,000,000) where the Procuring Entity may not hold a Pre-Bid Conference.

Section II. Instructions to Bidders

Notes on the Instructions to Bidders

This Section on the Instruction to Bidders (ITB) provides the information necessary for bidders to prepare responsive bids, in accordance with the requirements of the Procuring Entity. It also provides information on bid submission, eligibility check, opening and evaluation of bids, post-qualification, and on the award of contract.

1. **Scope of Bid**

The Procuring Entity, **Department of Social Welfare and Development (DSWD) Field Office IX** wishes to receive Bids for the **Construction of Skills Training Center for Bread and Pastries and Water Refilling Station at DSWD FOIX RRCY, Polanco, ZDN. ITB 2023-12-094**

The Procurement Project (referred to herein as “Project”) is composed of **One (1) lot** the details of which are described in Section VII (Technical Specifications)..

2. **Funding Information**

2.1. The GOP through the source of funding as indicated below for **2023** in the amount of **FIVE MILLION, SIX HUNDRED SIXTY-NINE THOUSAND, ONE HUNDRED SIXTY-ONE PESO(S) AND FIFTY-EIGHT HUNDREDTH(S) (Php ₱5,669,161.58)**.

2.2. The source of funding is:

- a. NGA, the General Appropriations Act or Special Appropriations.

3. **Bidding Requirements**

The Bidding for the Project shall be governed by all the provisions of RA No. 9184 and its 2016 revised IRR, including its Generic Procurement Manual and associated policies, rules and regulations as the primary source thereof, while the herein clauses shall serve as the secondary source thereof.

Any amendments made to the IRR and other GPPB issuances shall be applicable only to the ongoing posting, advertisement, or invitation to bid by the BAC through the issuance of a supplemental or bid bulletin.

The Bidder, by the act of submitting its Bid, shall be deemed to have inspected the site, determined the general characteristics of the contracted Works and the conditions for this Project, such as the location and the nature of the work; (b) climatic conditions; (c) transportation facilities; (c) nature and condition of the terrain, geological conditions at the site communication facilities, requirements, location and availability of construction aggregates and other materials, labor, water, electric power and access roads; and (d) other factors that may affect the cost, duration and execution or implementation of the contract, project, or work and examine all instructions, forms, terms, and project requirements in the Bidding Documents.

4. Corrupt, Fraudulent, Collusive, Coercive, and Obstructive Practices

The Procuring Entity, as well as the Bidders and Contractors, shall observe the highest standard of ethics during the procurement and execution of the contract. They or through an agent shall not engage in corrupt, fraudulent, collusive, coercive, and obstructive practices defined under Annex “I” of the 2016 revised IRR of RA No. 9184 or other integrity violations in competing for the Project.

5. Eligible Bidders

- 5.1. Only Bids of Bidders found to be legally, technically, and financially capable will be evaluated.
- 5.2. The Bidder must have an experience of having completed a Single Largest Completed Contract (SLCC) that is similar to this Project, equivalent to at least fifty percent (50%) of the ABC adjusted, if necessary, by the Bidder to current prices using the PSA’s CPI, except under conditions provided for in Section 23.4.2.4 of the 2016 revised IRR of RA No. 9184.

A contract is considered to be “similar” to the contract to be bid if it has the major categories of work stated in the **BDS**.

The Bidder’s SLCC should have been completed within ten (10) years prior to the deadline for the submission and receipt of bids.

- 5.3. For Foreign-funded Procurement, the Procuring Entity and the foreign government/foreign or international financing institution may agree on another track record requirement, as specified in the Bidding Document prepared for this purpose.
- 5.4. The Bidders shall comply with the eligibility criteria under Section 23.4.2 of the 2016 IRR of RA No. 9184.

6. Origin of Associated Goods

There is no restriction on the origin of Goods other than those prohibited by a decision of the UN Security Council taken under Chapter VII of the Charter of the UN.

7. Subcontracts

- 7.1. The Bidder may subcontract portions of the Project to the extent allowed by the Procuring Entity as stated herein, but in no case more than fifty percent (50%) of the Project.

The Procuring Entity has prescribed that:

- a. Subcontracting is not allowed.

8. Pre-Bid Conference

The Procuring Entity will hold a pre-bid conference for this Project on the specified date and time and either at its physical address at DSWD Field Office IX, Zamboanga City and/or through videoconferencing/webcasting} as indicated in paragraph 6 of the **IB**.

9. Clarification and Amendment of Bidding Documents

Prospective bidders may request for clarification on and/or interpretation of any part of the Bidding Documents. Such requests must be in writing and received by the Procuring Entity, either at its given address or through electronic mail indicated in the **IB**, at least ten (10) calendar days before the deadline set for the submission and receipt of Bids.

10. Documents Comprising the Bid: Eligibility and Technical Components

- 10.1. The first envelope shall contain the eligibility and technical documents of the Bid as specified in **Section IX. Checklist of Technical and Financial Documents**.
- 10.2. If the eligibility requirements or statements, the bids, and all other documents for submission to the BAC are in foreign language other than English, it must be accompanied by a translation in English, which shall be authenticated by the appropriate Philippine foreign service establishment, post, or the equivalent office having jurisdiction over the foreign bidder's affairs in the Philippines. For Contracting Parties to the Apostille Convention, only the translated documents shall be authenticated through an apostille pursuant to GPPB Resolution No. 13-2019 dated 23 May 2019. The English translation shall govern, for purposes of interpretation of the bid.
- 10.3. A valid special PCAB License in case of Joint Ventures, and registration for the type and cost of the contract for this Project. Any additional type of Contractor license or permit shall be indicated in the **BDS**.
- 10.4. A List of Contractor's key personnel (e.g., Project Manager, Project Engineers, Materials Engineers, and Foremen) assigned to the contract to be bid, with their complete qualification and experience data shall be provided. These key personnel must meet the required minimum years of experience set in the **BDS**.
- 10.5. A List of Contractor's major equipment units, which are owned, leased, and/or under purchase agreements, supported by proof of ownership, certification of availability of equipment from the equipment lessor/vendor for the duration of the project, as the case may be, must meet the minimum requirements for the contract set in the **BDS**.

11. Documents Comprising the Bid: Financial Component

- 11.1. The second bid envelope shall contain the financial documents for the Bid as specified in **Section IX. Checklist of Technical and Financial Documents**.
- 11.2. Any bid exceeding the ABC indicated in paragraph 1 of the **IB** shall not be accepted.
- 11.3. For Foreign-funded procurement, a ceiling may be applied to bid prices provided the conditions are met under Section 31.2 of the 2016 revised IRR of RA No. 9184.

12. Alternative Bids

Bidders shall submit offers that comply with the requirements of the Bidding Documents, including the basic technical design as indicated in the drawings and specifications. Unless there is a value engineering clause in the **BDS**, alternative Bids shall not be accepted.

13. Bid Prices

All bid prices for the given scope of work in the Project as awarded shall be considered as fixed prices, and therefore not subject to price escalation during contract implementation, except under extraordinary circumstances as determined by the NEDA and approved by the GPPB pursuant to the revised Guidelines for Contract Price Escalation guidelines.

14. Bid and Payment Currencies

14.1. Bid prices may be quoted in the local currency or tradeable currency accepted by the BSP at the discretion of the Bidder. However, for purposes of bid evaluation, Bids denominated in foreign currencies shall be converted to Philippine currency based on the exchange rate as published in the BSP reference rate bulletin on the day of the bid opening.

14.2. *Payment of the contract price shall be made in:*

- a. Philippine Pesos.

15. Bid Security

- 15.1. The Bidder shall submit a Bid Securing Declaration or any form of Bid Security in the amount indicated in the **BDS**, which shall be not less than the percentage of the ABC in accordance with the schedule in the **BDS**.
- 15.2. The Bid and bid security shall be valid **for Ninety (90) calendar days from opening of bids**. Any Bid not accompanied by an acceptable bid security shall be rejected by the Procuring Entity as non-responsive.

16. Sealing and Marking of Bids

Each Bidder shall submit one copy of the first and second components of its Bid.

The Procuring Entity may request additional hard copies and/or electronic copies of the Bid. However, failure of the Bidders to comply with the said request shall not be a ground for disqualification.

If the Procuring Entity allows the submission of bids through online submission to the given website or any other electronic means, the Bidder shall submit an electronic copy of its Bid, which must be digitally signed. An electronic copy that cannot be opened or is corrupted shall be considered non-responsive and, thus, automatically disqualified.

17. Deadline for Submission of Bids

The Bidders shall submit on the specified date and time and either at its physical address or through online submission as indicated in paragraph 7 of the **IB**.

18. Opening and Preliminary Examination of Bids

18.1. The BAC shall open the Bids in public at the time, on the date, and at the place specified in paragraph 9 of the **IB**. The Bidders' representatives who are present shall sign a register evidencing their attendance. In case videoconferencing, webcasting or other similar technologies will be used, attendance of participants shall likewise be recorded by the BAC Secretariat.

In case the Bids cannot be opened as scheduled due to justifiable reasons, the rescheduling requirements under Section 29 of the 2016 revised IRR of RA No. 9184 shall prevail.

18.2. The preliminary examination of Bids shall be governed by Section 30 of the 2016 revised IRR of RA No. 9184.

19. Detailed Evaluation and Comparison of Bids

19.1. The Procuring Entity's BAC shall immediately conduct a detailed evaluation of all Bids rated "*passed*" using non-discretionary pass/fail criteria. The BAC shall consider the conditions in the evaluation of Bids under Section 32.2 of 2016 revised IRR of RA No. 9184.

19.2. If the Project allows partial bids, all Bids and combinations of Bids as indicated in the **BDS** shall be received by the same deadline and opened and evaluated simultaneously so as to determine the Bid or combination of Bids offering the lowest calculated cost to the Procuring Entity. Bid Security as required by **ITB** Clause 15 shall be submitted for each contract (lot) separately.

19.3. In all cases, the NFCC computation pursuant to Section 23.4.2.6 of the 2016 revised IRR of RA No. 9184 must be sufficient for the total of the ABCs for all the lots participated in by the prospective Bidder.

20. Post Qualification

Within a non-extendible period of five (5) calendar days from receipt by the Bidder of the notice from the BAC that it submitted the Lowest Calculated Bid, the Bidder shall submit its latest income and business tax returns filed and paid through the BIR Electronic Filing and Payment System (eFPS), and other appropriate licenses and permits required by law and stated in the **BDS**.

21. Signing of the Contract

The documents required in Section 37.2 of the 2016 revised IRR of RA No. 9184 shall form part of the Contract. Additional Contract documents are indicated in the **BDS**.

Section III. Bid Data Sheet

Notes on the Bid Data Sheet (BDS)

The Bid Data Sheet (BDS) consists of provisions that supplement, amend, or specify in detail, information, or requirements included in the ITB found in Section II, which are specific to each procurement.

This Section is intended to assist the Procuring Entity in providing the specific information in relation to corresponding clauses in the ITB and has to be prepared for each specific procurement.

The Procuring Entity should specify in the BDS information and requirements specific to the circumstances of the Procuring Entity, the processing of the procurement, and the bid evaluation criteria that will apply to the Bids. In preparing the BDS, the following aspects should be checked:

- a. Information that specifies and complements provisions of the ITB must be incorporated.
- b. Amendments and/or supplements, if any, to provisions of the ITB as necessitated by the circumstances of the specific procurement, must also be incorporated.

Bid Data Sheet

ITB Clause													
5.2	<p>For this purpose, contracts similar to the Project refer to contracts which have the same major categories of work, which shall be:</p> <p><i>Construction of Building</i></p> <p><i>Project duration is expected to finish within 154 Calendar Day upon work commencement (NTP)</i></p> <p><i>The Bidder's SLCC as indicated in ITB Clause 5.2 should have been completed within ten (10) years prior to the deadline for the submission and receipt of bids.</i></p>												
7.1	<i>Subcontracting is not allowed.</i>												
10.3	<i>PCAB License, Category <u>"Atleast Category C and D., Size Range atleast "Small B"</u></i>												
10.4	<p style="color: red;">The key personnel must meet the required minimum years of experience set below:</p> <table style="width: 100%; border-collapse: collapse;"> <thead> <tr> <th style="text-align: left; color: red;"><u>Key Personnel</u></th> <th style="text-align: left; color: red;"><u>General Experience</u></th> <th style="text-align: left; color: red;"><u>Relevant Experience</u></th> </tr> </thead> <tbody> <tr> <td>Project Engineer</td> <td>5 yrs as practitioner</td> <td>5 yrs building construction</td> </tr> <tr> <td>Safety Officer</td> <td>3 yrs as practitioner</td> <td>3 yrs building construction</td> </tr> <tr> <td>Construction Foreman</td> <td>5 yrs as practitioner</td> <td>5 yrs building construction</td> </tr> </tbody> </table>	<u>Key Personnel</u>	<u>General Experience</u>	<u>Relevant Experience</u>	Project Engineer	5 yrs as practitioner	5 yrs building construction	Safety Officer	3 yrs as practitioner	3 yrs building construction	Construction Foreman	5 yrs as practitioner	5 yrs building construction
<u>Key Personnel</u>	<u>General Experience</u>	<u>Relevant Experience</u>											
Project Engineer	5 yrs as practitioner	5 yrs building construction											
Safety Officer	3 yrs as practitioner	3 yrs building construction											
Construction Foreman	5 yrs as practitioner	5 yrs building construction											
10.5	<p style="color: brown;">The minimum major equipment requirements are the following:</p> <table border="1" style="width: 100%; border-collapse: collapse; margin-top: 10px;"> <thead> <tr> <th style="text-align: center; color: blue;"><u>Equipment</u></th> <th style="text-align: center; color: blue;"><u>Capacity</u></th> <th style="text-align: center; color: blue;"><u>Number of Units</u></th> </tr> </thead> <tbody> <tr> <td style="vertical-align: top;">Welding Machine Electric Sander Bagger Concrete Mixer</td> <td></td> <td style="vertical-align: top;">Atleast 1</td> </tr> </tbody> </table>	<u>Equipment</u>	<u>Capacity</u>	<u>Number of Units</u>	Welding Machine Electric Sander Bagger Concrete Mixer		Atleast 1						
<u>Equipment</u>	<u>Capacity</u>	<u>Number of Units</u>											
Welding Machine Electric Sander Bagger Concrete Mixer		Atleast 1											
12	<i>[Insert Value Engineering clause if allowed.]</i>												
15.1	<p>The bid security shall be in the form of a Bid Securing Declaration or any of the following forms and amounts:</p> <p style="margin-left: 20px;">a. The amount of not less than Php ₱113,383.23 <i>[Indicate the amount equivalent to two percent (2%) of ABC]</i>, if bid security is in cash, cashier's/manager's check, bank draft/guarantee or irrevocable letter of credit; or;</p>												

	b. The amount of not less than Php ₱283,458.08 <i>[Indicate the amount equivalent to five percent (5%) of ABC]</i> if bid security is in Surety Bond..
19.2	Partial bids are NOT allowed
20	<i>[List licenses and permits relevant to the Project and the corresponding law requiring it, e.g. Environmental Compliance Certificate, Certification that the project site is not within a geohazard zone, etc.]</i> Secure Permits and Clearances as maybe required by the Local Government
21	Additional contract documents relevant to the Project that may be required by existing laws and/or the Procuring Entity, such as construction schedule and S-curve, manpower schedule, construction methods, equipment utilization schedule, construction safety and health program approved by the DOLE, and other acceptable tools of project scheduling.

Section IV. General Conditions of Contract

Notes on the General Conditions of Contract

The General Conditions of Contract (GCC) in this Section, read in conjunction with the Special Conditions of Contract in Section V and other documents listed therein, should be a complete document expressing all the rights and obligations of the parties.

Matters governing performance of the Contractor, payments under the contract, or matters affecting the risks, rights, and obligations of the parties under the contract are included in the GCC and Special Conditions of Contract.

Any complementary information, which may be needed, shall be introduced only through the Special Conditions of Contract.

1. **Scope of Contract**

This Contract shall include all such items, although not specifically mentioned, that can be reasonably inferred as being required for its completion as if such items were expressly mentioned herein. All the provisions of RA No. 9184 and its 2016 revised IRR, including the Generic Procurement Manual, and associated issuances, constitute the primary source for the terms and conditions of the Contract, and thus, applicable in contract implementation. Herein clauses shall serve as the secondary source for the terms and conditions of the Contract.

This is without prejudice to Sections 74.1 and 74.2 of the 2016 revised IRR of RA No. 9184 allowing the GPPB to amend the IRR, which shall be applied to all procurement activities, the advertisement, posting, or invitation of which were issued after the effectivity of the said amendment.

2. **Sectional Completion of Works**

If sectional completion is specified in the **Special Conditions of Contract (SCC)**, references in the Conditions of Contract to the Works, the Completion Date, and the Intended Completion Date shall apply to any Section of the Works (other than references to the Completion Date and Intended Completion Date for the whole of the Works).

3. **Possession of Site**

3.1 The Procuring Entity shall give possession of all or parts of the Site to the Contractor based on the schedule of delivery indicated in the **SCC**, which corresponds to the execution of the Works. If the Contractor suffers delay or incurs cost from failure on the part of the Procuring Entity to give possession in accordance with the terms of this clause, the Procuring Entity's Representative shall give the Contractor a Contract Time Extension and certify such sum as fair to cover the cost incurred, which sum shall be paid by Procuring Entity.

3.2 If possession of a portion is not given by the above date, the Procuring Entity will be deemed to have delayed the start of the relevant activities. The resulting adjustments in contract time to address such delay may be addressed through contract extension provided under Annex "E" of the 2016 revised IRR of RA No. 9184.

4. **The Contractor's Obligations**

The Contractor shall employ the key personnel named in the Schedule of Key Personnel indicating their designation, in accordance with **ITB** Clause 10.3 and specified in the **BDS**, to carry out the supervision of the Works.

The Procuring Entity will approve any proposed replacement of key personnel only if their relevant qualifications and abilities are equal to or better than those of the personnel listed in the Schedule.

5. Performance Security

- 5.1. Within ten (10) calendar days from receipt of the Notice of Award from the Procuring Entity but in no case later than the signing of the contract by both parties, the successful Bidder shall furnish the performance security in any of the forms prescribed in Section 39 of the 2016 revised IRR.
- 5.2. The Contractor, by entering into the Contract with the Procuring Entity, acknowledges the right of the Procuring Entity to institute action pursuant to RA No. 3688 against any subcontractor be they an individual, firm, partnership, corporation, or association supplying the Contractor with labor, materials and/or equipment for the performance of this Contract.

6. Site Investigation Reports

The Contractor, in preparing the Bid, shall rely on any Site Investigation Reports referred to in the SCC supplemented by any information obtained by the Contractor.

7. Warranty

- 7.1. In case the Contractor fails to undertake the repair works under Section 62.2.2 of the 2016 revised IRR, the Procuring Entity shall forfeit its performance security, subject its property(ies) to attachment or garnishment proceedings, and perpetually disqualify it from participating in any public bidding. All payables of the GOP in his favor shall be offset to recover the costs.
- 7.2. The warranty against Structural Defects/Failures, except that occasioned-on force majeure, shall cover the period from the date of issuance of the Certificate of Final Acceptance by the Procuring Entity. Specific duration of the warranty is found in the SCC.

8. Liability of the Contractor

Subject to additional provisions, if any, set forth in the SCC, the Contractor's liability under this Contract shall be as provided by the laws of the Republic of the Philippines.

If the Contractor is a joint venture, all partners to the joint venture shall be jointly and severally liable to the Procuring Entity.

9. Termination for Other Causes

Contract termination shall be initiated in case it is determined *prima facie* by the Procuring Entity that the Contractor has engaged, before, or during the implementation of the contract, in unlawful deeds and behaviors relative to contract acquisition and implementation, such as, but not limited to corrupt, fraudulent, collusive, coercive, and obstructive practices as stated in **ITB** Clause 4.

10. Dayworks

Subject to the guidelines on Variation Order in Annex “E” of the 2016 revised IRR of RA No. 9184, and if applicable as indicated in the SCC, the Dayworks rates in the Contractor’s Bid shall be used for small additional amounts of work only when the Procuring Entity’s Representative has given written instructions in advance for additional work to be paid for in that way.

11. Program of Work

11.1. The Contractor shall submit to the Procuring Entity’s Representative for approval the said Program of Work showing the general methods, arrangements, order, and timing for all the activities in the Works. The submissions of the Program of Work are indicated in the SCC.

11.2. The Contractor shall submit to the Procuring Entity’s Representative for approval an updated Program of Work at intervals no longer than the period stated in the SCC. If the Contractor does not submit an updated Program of Work within this period, the Procuring Entity’s Representative may withhold the amount stated in the SCC from the next payment certificate and continue to withhold this amount until the next payment after the date on which the overdue Program of Work has been submitted.

12. Instructions, Inspections and Audits

The Contractor shall permit the GOP or the Procuring Entity to inspect the Contractor’s accounts and records relating to the performance of the Contractor and to have them audited by auditors of the GOP or the Procuring Entity, as may be required.

13. Advance Payment

The Procuring Entity shall, upon a written request of the Contractor which shall be submitted as a Contract document, make an advance payment to the Contractor in an amount not exceeding fifteen percent (15%) of the total contract price, to be made in lump sum, or at the most two installments according to a schedule specified in the SCC, subject to the requirements in Annex “E” of the 2016 revised IRR of RA No. 9184.

14. Progress Payments

The Contractor may submit a request for payment for Work accomplished. Such requests for payment shall be verified and certified by the Procuring Entity’s Representative/Project Engineer. Except as otherwise stipulated in the SCC, materials and equipment delivered on the site but not completely put in place shall not be included for payment.

15. Operating and Maintenance Manuals

- 15.1. If required, the Contractor will provide “as built” Drawings and/or operating and maintenance manuals as specified in the **SCC**.
- 15.2. If the Contractor does not provide the Drawings and/or manuals by the dates stated above, or they do not receive the Procuring Entity’s Representative’s approval, the Procuring Entity’s Representative may withhold the amount stated in the **SCC** from payments due to the Contractor.

Section V. Special Conditions of Contract

Notes on the Special Conditions of Contract

Similar to the BDS, the clauses in this Section are intended to assist the Procuring Entity in providing contract-specific information in relation to corresponding clauses in the GCC found in Section IV.

The Special Conditions of Contract (SCC) complement the GCC, specifying contractual requirements linked to the special circumstances of the Procuring Entity, the Procuring Entity's country, the sector, and the Works procured. In preparing this Section, the following aspects should be checked:

- a. Information that complements provisions of the GCC must be incorporated.
- b. Amendments and/or supplements to provisions of the GCC as necessitated by the circumstances of the specific purchase, must also be incorporated.

However, no special condition which defeats or negates the general intent and purpose of the provisions of the GCC should be incorporated herein.

Special Conditions of Contract

GCC Clause	
2	<p><i>[If different dates are specified for completion of the Works by section, i.e. “sectional completion,” these dates should be listed here.]</i></p> <p><i>Please refer to Section VI. Specifications.</i></p>
4.1	<p><i>[Specify the schedule of delivery of the possession of the site to the Contractor, whether full or in part.]</i></p> <p><i>Upon Receipt of Notice to Proceed from the PE, effective immediately the contractor can commence already the full implementation</i></p>
6	<p>The site investigation reports are: <i>[list here the required site investigation reports.</i></p> <p><i>Not Needed</i></p>
7.2	<p><i>[Select one, delete the other.]</i></p> <p><i>[In case of semi-permanent structures, such as buildings of types 1, 2, and 3 as classified under the National Building Code of the Philippines, concrete/asphalt roads, concrete river control, drainage, irrigation lined canals, river landing, deep wells, rock causeway, pedestrian overpass, and other similar semi-permanent structures:]</i> <i>Five (5) years.</i></p>
10	<p>N/A</p>
11.1	<p>The Contractor shall submit the Program of Work to the Procuring Entity’s Representative within <i>[5]</i> days of delivery of the Notice of Award.</p>
11.2	<p>The amount to be withheld for late submission of an updated Program of Work is <i>1% of the ABC</i></p>
13	<p>The amount of the advance payment is <i>[insert amount as percentage of the contract price that shall not exceed 15% of the total contract price and schedule of payment].</i><i>The amount of the advance payment is 15% of the total contract price and schedule of payment. The Procuring Entity shall, upon a written request of the Contractor which shall be submitted as a Contract document, make an advance payment to the Contractor in an amount not exceeding fifteen percent (15%) of the total contract price, to be made in lump sum. The advance payment shall be made only upon the submission to and acceptance by the procuring entity of an irrevocable standby letter of credit of equivalent value from a commercial bank, a bank guarantee or a surety bond callable upon demand, issued by a surety or insurance company duly licensed by the Insurance Commission and confirmed by the procuring entity. The advance payment shall be repaid by the</i></p>

	<i>contractor by deducting fifteen percent (15%) from his periodic progress payments, a percentage equal to the percentage of the total contract price used for the advance payment. The contractor may reduce his standby letter of credit or guarantee instrument by the amounts refunded by the Monthly Certificates in the advance payment</i>
14	<p><i>[If allowed by the Procuring Entity, state:]</i> Materials and equipment delivered on the site but not completely put in place shall be included for payment.</p> <p>Payments to the CONTRACTOR will be made only for the actual accomplishment and/or material utilized, which may be subdivided into progress percentages, specifically initial billing is at least 20%, of the total WORKS, certified by the DSWD Engineer as performed by the CONTRACTOR in accordance with the plans, specifications and program of works/construction schedule</p>
15.1	<p>The date by which operating and maintenance manuals are required is <i>[date]</i>.</p> <p>The date by which “as built” drawings are required is <i>[date]</i>.</p> <p>The contractor must provide with as “built” Plan drawings 15 days after completion of the project certified by the DSWD Engineer</p>
15.2	<p>The amount to be withheld for failing to produce “as built” drawings and/or operating and maintenance manuals by the date required is <i>[amount in local currency]</i>.</p> <p>Non - provision of as “built” drawings after 15 days of project completion, the PE will withhold 1% of the contract cost</p>

Section VI. Specifications

Notes on Specifications

A set of precise and clear specifications is a prerequisite for Bidders to respond realistically and competitively to the requirements of the Procuring Entity without qualifying or conditioning their Bids. In the context of international competitive bidding, the specifications must be drafted to permit the widest possible competition and, at the same time, present a clear statement of the required standards of workmanship, materials, and performance of the goods and services to be procured. Only if this is done will the objectives of economy, efficiency, and fairness in procurement be realized, responsiveness of Bids be ensured, and the subsequent task of bid evaluation facilitated. The specifications should require that all goods and materials to be incorporated in the Works be new, unused, of the most recent or current models, and incorporate all recent improvements in design and materials unless provided otherwise in the Contract.

Samples of specifications from previous similar projects are useful in this respect. The use of metric units is mandatory. Most specifications are normally written specially by the Procuring Entity or its representative to suit the Works at hand. There is no standard set of Specifications for universal application in all sectors in all regions, but there are established principles and practices, which are reflected in these PBDs.

There are considerable advantages in standardizing General Specifications for repetitive Works in recognized public sectors, such as highways, ports, railways, urban housing, irrigation, and water supply, in the same country or region where similar conditions prevail. The General Specifications should cover all classes of workmanship, materials, and equipment commonly involved in construction, although not necessarily to be used in a particular Works Contract. Deletions or addenda should then adapt the General Specifications to the particular Works.

Care must be taken in drafting specifications to ensure that they are not restrictive. In the specification of standards for goods, materials, and workmanship, recognized international standards should be used as much as possible. Where other particular standards are used, whether national standards or other standards, the specifications should state that goods, materials, and workmanship that meet other authoritative standards, and which ensure substantially equal or higher quality than the standards mentioned, will also be acceptable. The following clause may be inserted in the SCC.

Sample Clause: Equivalency of Standards and Codes

Wherever reference is made in the Contract to specific standards and codes to be met by the goods and materials to be furnished, and work performed or tested, the provisions of the latest current edition or revision of the relevant standards and codes in effect shall apply, unless otherwise expressly stated in the Contract. Where such standards and codes are national, or relate to a particular country or region, other authoritative standards that ensure a substantially equal or higher quality than the standards and codes specified will be

accepted subject to the Procuring Entity's Representative's prior review and written consent. Differences between the standards specified and the proposed alternative standards shall be fully described in writing by the Contractor and submitted to the Procuring Entity's Representative at least twenty-eight (28) days prior to the date when the Contractor desires the Procuring Entity's Representative's consent. In the event the Procuring Entity's Representative determines that such proposed deviations do not ensure substantially equal or higher quality, the Contractor shall comply with the standards specified in the documents.

These notes are intended only as information for the Procuring Entity or the person drafting the Bidding Documents. They should not be included in the final Bidding Documents.

TECHNICAL SPECIFICATION

Requesting OBSU	: DSWD FO IX CRCF
TA Subject/Title	: Construction of Skills Training Center for Bread and Pastries and Water Refilling Station at DSWD FOIX RRCY, Polanco, ZDN
Project Duration	: 154 CALENDAR DAYS Upon Receipt of Notice to Proceed from the PE, effective immediately the contractor can commence already the full implementation

Item	Description and Specification	Actual/Sample Picture <i>(if applicable)</i>
1	<p>Facilities of the Engineer – the following shall be provided by the contractor following the conditions as stated in “Part A & B of the DPWH Blue Book Vol. 2.</p> <ul style="list-style-type: none"> a. Office & Laboratories b. Transportation Services c. Project Engineer & Assistant d. Communication e. Photographs of the construction activities. f. Workmen Accommodation g. Medical Room and other First Aid Facilities h. Latrines 	<p>Refer to DPWH Blue Book Volumes 2 & 3</p>
	<p>GENERAL</p> <p>All parts of the construction shall be finished with first-class workmanship to the fullest talent and meaning of the plans and Specifications and to the full satisfaction of the DSWD technical personnel and the end-user.</p> <p>The DSWD should be informed in writing of any revisions or variances seen in the actual implementation. Any variance to be made is not permitted unless otherwise approved by DSWD.</p> <p>Work will commence upon the issuance of Notice to Proceed by DSWD. Payment shall be based on the actual percentage of accomplishment, to be validated by the RPMT Engineers and end-user.</p> <p>The warranty is One (1) year from project completion up to final acceptance or the defects liability period as stated in the 2016 Revised IRR of RA 9184.</p> <p>The contractor shall undertake the repair works, at his own expense, of any defect or damage to the infrastructure projects on account of the use of materials of inferior quality within ninety (90) days from the time the Head of the Procuring Entity has issued an order to undertake repair.</p> <p>It shall be the responsibility of the contractor to complete the project amidst any impediments that will arise during the implementation phase.</p> <p>The period for the completion of the project will not be affected by any equipment breakdown or damaged during implementation. Immediate replacement shall be shouldered by the contractor. Delays will be subjected to liquidated damages provided in RA 9184.</p>	

	<p>Failure of the contractor to abide on all the provisions stipulated herein shall give rise to the right of DSWD Site Engineer to order stoppage of work, upon the issuance of Notice of Suspension approved by the head of the agency, while the period to complete the project shall continue to run, in addition to the penalties that may be imposed by this agency and/or local and national government agencies for non-compliance of this provision.</p> <p>The contractor shall furnish As-Built Plan and other technical documents (PERT-CPM, Logbook of Daily Activities) as part of the requirement for issuance of Completion Certificate and Final Billing payment.</p>	
	<p>Material Testing</p> <p>All materials to be used for this contract shall be inspected, tested and accepted by the concerned unit or agency prior installation. Failure to comply with this provision, the implementing unit shall have the right to order "REMOVE AND REPLACE" the said materials at the expense of the contractor with the period continue to run and without time extension.</p> <p>It is a matter of requirement that the contracting company must have its own materials engineer, who shall be at the premises of the principal office of the contracting company during inspection. Appropriate licenses and documents shall be readily available.</p> <p>The contractor cannot proceed with the next work item unless he can present that the materials indeed passed the testing requirements, in which case, the DSWD site engineers have the right to demand from the contractor, otherwise, the DSWD site engineers may order the stoppage of work while the period to complete the project shall continue to run.</p> <p>Material Testing for Structural Concrete, Reinforcements and Structural Steel is required as per testing standard of DPWH (Department of Public Works & Highways).</p>	
2	<p>DEMOLITION WORKS</p> <p>Demolition works shall be executed with harness. Existing roofing shall be removed and be secured in place where our elderly individuals cannot be harmed. The area shall be well secured and that the clients of the center cannot easily get in and to avoid accidents. They should secure that debris will not harm the people around specially the clients.</p> <p><input type="checkbox"/></p>	Refer to DPWH Blue Book Volumes 2 & 3
	<p>SITE WORKS</p> <p>A. Clearing and Layout</p> <p>Clearing must be carried out in advance of any site works operations. The building site shall be levelled to a suitable grade in accordance to the plan. This shall include the removal of all foreign material and vegetation, except trees and plants required to be preserved, from within the boundaries of areas affected by earthworks or other areas to be cleared as designated on the Drawings. All foreign material and vegetation cleared except topsoil must be removed from the site and is to be deposited at the appropriate disposal site. Burning off of these materials is not permitted.</p> <p>Prior to any excavation works, the building lines shall be staked out and all lines and grades shown in the drawings accurately established. Batter boards where construction reference marks have been indicated should be erected such they would not be disturbing during the excavation for the foundation of the building.</p> <p>B. Structural Excavation</p> <p>All excavation shall be made to grade in the drawings. Where the building site is covered with any kind of fill, the excavation for footings shall be made deeper until the specified capacity of soil is reached.</p> <p>If water is present at the excavation site, it shall be removed by bailing or pumping. Great care should be taken in order that the surrounding soil is not eroded or cave in.</p> <p>C. Embankment: Filling, Grading and Compaction</p>	Refer to DPWH Blue Book Volumes 2 & 3 Item 800-clearing. grabbing Item 801- Removal of Structures and Obstruction Item 802- Excavation Item 803 – Structural Excvation Item 804 – Embankment Item 805 - Dredging

	<p>Fill shall be of well compacted, well graded earth or sand and shall be free from tree stumps, organic matter, seed and peat etc. The materials removed from the excavations shall be used for filling. Where earth or sand from source other than excavation at site is used, the quality of such earth or sand shall be the same as that obtained from excavation at site, or superior to it.</p> <p>The fills and back fills shall be placed in layers not more than 300mm in thickness. Each succeeding layer shall be thoroughly compacted by wetting, tamping and rolling.</p> <p>D. Gravel Bedding</p> <p>Gravel used for bedding shall be spread uniformly along the full length of the Column Footing and Wall Footing. The bedding shall be constructed so that after compacting, a depth of at least 100 mm of gravel remains under the full length of the structure.</p>	
	<p>CONCRETE WORKS</p> <p>Concrete should be mixed thoroughly such that there is uniform distribution among the cement and aggregates. The concrete should be vibrated and its forms should be tapped as it is deposited to its final position, to prevent formation of voids in the concrete member which will weaken the structure.</p> <p>Water to be used for mixing concrete shall be clean and free from amounts of oil, acids, salts, alkalis, and other organic material.</p> <p>All concrete works for this project shall be undertaken in accordance with the standard specifications for plain and reinforced concrete as approved by the government.</p> <p>Concrete shall always be mixed in mechanical mixer. Water shall not, normally, be charged into the drum of the mixer until all other ingredients are already in the drum and mixed for at least one minute. Mixing shall be continued until there is uniform distribution of materials and the mass is uniform in colours and consistency.</p> <p>Class A concrete shall be a mixture of 1 part cement, 2 parts fine aggregates and 4 parts coarse aggregate by volume, plus enough water to make the mixture into a pliable paste.</p>	<p>Refer to DPWH Blue Book Volumes 2 & 3 Item 900 – structural concrete Item 1021 – cement floor finish</p>
finish	<p>REINFORCING STEEL BARS</p> <p>Reinforcing Steel Bars to be used for this project shall consist of standard deformed structural bars meeting ASTM specifications.</p> <p>Reinforcement Steel shall be carefully and accurately cut, bent or formed to the dimensions and configurations shown in the plans. Bends should be in accordance with the latest National Structural Code of the Philippines. They shall be tied together at each bar intersection with gauge no. 16 G.I wire.</p> <p>Before steel reinforcement is placed in position, the surface of the reinforcement shall be cleaned of rust, dust, grease and other objectionable substances which would destroy or reduce the bond with concrete. The reinforcement bars must be positioned such that there is space between the steel at sides and bottom of the forms.</p>	<p>Refer to DPWH Blue Book Volumes 2 & 3</p>
	<p>FORMWORKS AND SCAFFOLDING</p> <p>Forms shall be used wherever necessary to confine the concrete during vibration and to shape it to the required line. The formwork shall conform to shapes, lines, levels and dimensions of the concrete sections shown on the plans.</p> <p>Forms shall have sufficient strength to withstand the pressure resulting from placement and vibration of concrete and shall be maintained rigidly in position. Formworks for all reinforced concrete shall be adequately supported and braced or tied together to maintain the correct positions and the shapes of poured concrete. Wooden forms shall be constructed sufficiently tight to prevent the bulging of concrete members upon pouring or leaking/draining of water during curing.</p> <p>The forms shall not be removed until the concrete has attained sufficient strength to support its own weight and any temporary loads placed on it. The side forms of girders and beams may be removed earlier than the bottom forms. However, additional supports and shoring must be placed under until they have attained strength.</p> <p>Form works shall be removed carefully so as to prevent damage to the concrete. Wooden wedge only shall be used between the concrete surface and the form where force is necessary to separate the form from the concrete. Metal wedge,</p>	<p>Refer to DPWH Blue Book Volumes 2 & 3</p>

	<p>bars or tools shall not be used for this purpose. Any concrete damaged in the process of removing the forms shall be repaired in accordance with the provision of concrete specifications.</p> <p>Double scaffolding having two seats of vertical supports shall be provided. The supports shall be sound and strong, tied together with horizontal pieces over which scaffolding planks shall be fixed.</p>	
	<p>MASONRY WORKS</p> <p>A. CHB Laying</p> <p>The concrete hollow blocks to be used shall be 4"x8"x16". All cells of concrete hollow blocks to be laid shall be filled with cement mortar fixture of 1 part cement and 2 parts sand, by volume. The horizontal joints between units shall be provided with 1:2 cement mortar mixtures having a thickness of 0.012 meters. All concrete hollow block walls shall be reinforced with 10mm diameter deformed bars spaced 0.60 meters both ways for every concrete hollow block laid horizontally and vertically. Reinforcements for the CHB shall be doweled to the reinforcements of the existing floor slab. Chipping is required to be able to expose the steel bars of the floor slab.</p> <p>B. Plastering</p> <p>Masonry and concrete surfaces which call for application of plaster shall be clean, free from dust and loose mortar. Efflorescence if any shall be removed by brushing and scrapping. For masonry surfaces the joints shall be raked out properly, while the concrete surfaces shall be roughed by wire brushing and hacking ensuring proper bonding of plastering mix. The surface shall then be thoroughly washed with water, cleaned and kept wet before plastering is commenced. Mortar for plastering should be Class A mixture having a thickness of 0.020 meters.</p>	<p>Refer to DPWH Blue Book Volumes 2 & 3</p>
	<p>CARPENTRY</p> <p>This item shall consist of furnishing and placing of carpentry items as to type, size and shape as shown on plans and detailed estimate. The Gypsum boards shall be screw fixed to the underside of the metal furring. Joint in the board shall be finished flush with fillers, finisher and primer as per manufacturer's recommendation to give a seamless finish. Necessary cut-outs for Electrical and other fixtures shall be provided with a framing of wall channels. The finished ceiling shall be perfectly leveled and aligned, at desired height as per drawings.</p>	<p>Refer to DPWH Blue Book Volumes 2 & 3 Item 1003 Carpentry & joinery works</p>
	<p>METAL WORKS</p> <p>A. Roof Frame</p> <p>This item consists of furnishing and installation of labor, equipment and tools performing all operations necessary to fabricate, erect and construct a fabricated steel roof frame. The materials to be used for the roof framing such as trusses, struts and web members shall consist of steel angles ¼" thick. Other accessories for the roof frames are shown in the details of truss joints and in the roof framing plan. As specified in the plan, all steel joints and connection must be fully welded. Ensure that the materials are in proper position before welding. Prior to the erection of the Steel Frame, each frame shall be inspected by the DSWD Engineers to ensure the quality of the workmanship. The anchors bolts used to secure the connection of the steel frame to the column shall be tied to the reinforcing steel bars with gauge #16 G.I. wire. Steel deck with a thickness of 0.8mm shall be used as a part of the second floor slab.</p> <p>B. Metal Furring</p> <p>This item shall include the furnishing and installation of grid system for supporting ceiling boards.</p>	<p>Refer to DPWH Blue Book Volumes 2 & 3</p>

	<p>The carrying channel and double metal furring shall be placed 1.20 meters and 0.60 meters apart, respectively. W-clips will be used to carry the double metal furring which will be placed at each intersection between the carrying channel and double metal furring. J-clips, threaded rods and anchor bolts will also be furnished for additional support.</p> <p>The metal furring system shall be perfectly levelled and aligned at desired height.</p> <p>C. Railings</p> <p>Provide Steel Hand Railings shall be 2" diameter Stainless Pipe for Ramps. Stainless L-Type grab railing for toilets. 2" diameter G.I Pipe for railings of Emergency Exits to painted with black.</p>	
	<p>ROOFING WORKS</p> <p>The Roofing Sheets shall be pre-painted G.I. Roofing (Gauge #26). It shall be free from rust and the zinc covering the time of fixing shall be on perfect condition. The installation of roofing sheets with end laps shall start at the lower part of the roof. Each sheet shall be laid on steel purlins with an end overlap of 100mm minimum. Succeeding upper rows of sheets shall be installed in the same manner until the entire roof area is covered. Sheets should be handled carefully to prevent damage.</p> <p>Ridge and hips shall be bolted with at least 250mm lap placed over the roofing sheets on either side so as to prevent the rain driving under it and together shall be riveted at every second corrugation.</p>	<p>Refer to DPWH Blue Book Volumes 2 & 3 Item 1013 – Corrugated Metal Roofing Item 1014 – Pre-painted Metal Sheets</p>
	<p>PLUMBING WORKS</p> <p>This item shall consist of furnishing all materials, tools, equipment and fixtures required as shown on the plans for the satisfactory performance of the entire plumbing system including installation in accordance with the latest edition of the National Building Code, and this specification.</p> <p>All piping materials, fixtures and appliances fitting accessories whether specifically mentioned or not but necessary to complete this item shall be furnished and installed. All plumbing rough-in shall be polyvinyl chloride pipes. Pipes and fitting materials shall comply with specification requirements.</p> <p>An automatic fire sprinkler shall be provided in all rooms. Supply, install, set to work, test, commission, fully certify and handover a sprinkler system in accordance with the function and performance requirements and as stated in the Rules for Automatic Sprinkler Installations published by the Loss Prevention Council (LPC Rules) incorporating BS EN 12845.</p> <p>Ensure all piping is free from burrs, rust and scale and thoroughly cleaned prior to installation in accordance with QA procedures that shall be available to view on request. During installation of the Works, plug or cap all open ends with purpose-made iron or plastic closures to prevent ingress of dirt. On completion thoroughly flush each system out with clean water. Ensure that adequate drain points are provided for this purpose.</p> <p>The Sprinkler system shall be tested prior in the turning-over of the project.</p>	<p>Refer to DPWH Blue Book Volumes 2 & 3 Item 1017 – Storm Drain & Sewerage System ITEM 1202 – AUTOMATIC WATER SPRINKLER SYSTEM ITEM 1206 - HEATING SYSTEM</p>
	<p>PAINTING WORKS</p> <p>All painting works for this project shall be executed with first class workmanship. Surfaces should be thoroughly cleaned to remove mortar, dust, grease, rust, and other foreign substances that may be present on areas to be painted. Surface defects such as cracks, dents, and holes must be filled with putty and sandpapered before final coat of paint is applied. The overall color scheme to be followed in painting the structure shall be left to the decision of the DSWD technical personnel. The paint shall be applied by means of brush or roller. No brush marks, no hair marks no clogging of paint puddles shall be permitted.</p>	<p>Refer to DPWH Blue Book Volumes 2 & 3: item 1032 - PAINTING, VARNISHING, AND OTHER RELATED WORKS</p>

	<p>ELECTRICAL WORKS</p> <p>This item shall consist of the furnishing and installation of the complete conduit work consisting of electrical conduits, conduits boxes such as junction boxes, pull boxes, utility boxes, octagonal and square boxes; conduit fittings such as couplings, locknuts and bushings and other electrical materials needed to complete the conduit roughing-in work of this project.</p> <p>All materials shall be brand new and shall be of approved type meeting all the requirements of the Philippine Electrical Code and bearing the Philippine Standard Agency (PSA) mark.</p> <p>All lighting fixtures and lamps are specified and listed on lighting fixture schedule. Upon completion of the electrical construction work, the contractor shall provide all test equipment and personnel and to submit written copies of all test results.</p> <p>The contractor shall guarantee the electrical installation are done and in accordance with the approved plans and specifications. The contractor shall guarantee that the electrical system is free from all grounds and from all defective workmanship and materials and will remain so for a period of one year from date and acceptance of works. Any defect shall be remedied by the contractor at his own expense.</p> <p>Air Conditioning Units shall be in premium quality and has warranty to ensure that any defects shall be shouldered by the contractor.</p>	<p>Refer to DPWH Blue Book Volumes 2 & 3 Item 1100 – Conduits, boxes & Fittings ITEM 1101 - WIRES AND WIRING DEVICES ITEM 1102 - POWER LOAD CENTER, SWITCHGEAR AND PANELBOARDS ITEM 1200 - AIR CONDITIONING AND REFRIGERATION SYSTEM</p>
	<p>SIGNAGES</p> <p>The General Contractor shall provide Billboards for precautions for Public Safety. Billboard signage should be 4'x8' and to be placed in front of the project site. Provide Panaflex Signboard, 0.60mx0.80m single face, lighted photographic flex, to be installed at the location as shown in the plan.</p> <p>Four (4) pieces stainless lettering with a dimension of 8" x 8" x 2" and 34 pieces stainless lettering with a dimension 2" x 2" x 1" shall be welded in embedded steel on the 1.1m x 0.8m concrete with 2" thick concrete pedestal base shall be fabricated and painted prior to installation. This shall be installed indicated in the plan.</p> <p>Concrete Sign Board with the logo of DSWD that has a dimension of 0.9m x 0.6m and concrete letterings with 2" thickness concrete pedestal base shall be fabricated and painted to be installed indicated in the plan.</p>	<p>Refer to DPWH Blue Book Volumes 2 & 3</p>
	<p>CONSTRUCTION SAFETY AND HEALTH</p> <p>A safety officer should be at the construction site at all times during the construction phase. It is the responsibility of the safety officer to ensure that construction workers are following established policies and safety regulations.</p>	
	<p>CONSTRUCTION SUPERVISOR/FOREMAN</p> <p>Similar to the Safety Officer, the Construction Foreman should be at the construction site at all times during the construction phase. The foreperson will schedule work for the crew and may also be responsible for making proposals and obtaining new jobs. Close coordination between the foreman and DSWD Technical Personnel is a must to ensure that all specifications are met.</p>	

Section VII. Drawings



ARCHITECTURAL NOTES

1. ALL DIMENSIONS ARE IN METERS UNLESS OTHERWISE SPECIFIED.
2. ALL MATERIALS AND FINISHES SHALL BE AS SPECIFIED IN THE DRAWINGS.
3. ALL WORK SHALL BE DONE IN ACCORDANCE WITH THE LATEST REVISIONS OF THE PHILIPPINE STANDARDS AND CODES.
4. THE CONTRACTOR SHALL BE RESPONSIBLE FOR OBTAINING ALL NECESSARY PERMITS AND APPROVALS FROM THE APPROPRIATE AGENCIES.
5. THE CONTRACTOR SHALL MAINTAIN ACCESS TO ALL ADJACENT PROPERTIES AND UTILITIES AT ALL TIMES.
6. ALL UTILITIES SHALL BE PROTECTED AND DEEPENED AS NECESSARY TO ACCOMMODATE THE PROPOSED CONSTRUCTION.
7. THE CONTRACTOR SHALL BE RESPONSIBLE FOR THE PROTECTION AND REPAIR OF ALL EXISTING UTILITIES AND STRUCTURES.
8. ALL MATERIALS AND FINISHES SHALL BE APPROVED BY THE ARCHITECT BEFORE INSTALLATION.
9. THE CONTRACTOR SHALL MAINTAIN A NEAT AND ORDERLY WORK SITE AT ALL TIMES.
10. ALL WASTE AND DEBRIS SHALL BE PROPERLY DISPOSED OF AT ALL TIMES.
11. THE CONTRACTOR SHALL BE RESPONSIBLE FOR THE PROTECTION AND REPAIR OF ALL EXISTING UTILITIES AND STRUCTURES.
12. ALL MATERIALS AND FINISHES SHALL BE APPROVED BY THE ARCHITECT BEFORE INSTALLATION.
13. THE CONTRACTOR SHALL MAINTAIN A NEAT AND ORDERLY WORK SITE AT ALL TIMES.
14. ALL WASTE AND DEBRIS SHALL BE PROPERLY DISPOSED OF AT ALL TIMES.

TABLE OF CONTENTS

CS-1	COVER SHEET
AR-01	ARCHITECTURAL NOTES
AR-02	TABLE OF CONTENTS
AR-03	CONSTRUCTION OF BAKERY WITH WATER REPELLING STATION
AR-04	CONSTRUCTION OF BAKERY WITH WATER REPELLING STATION
AR-05	CONSTRUCTION OF BAKERY WITH WATER REPELLING STATION
ST-01	CONSTRUCTION OF BAKERY WITH WATER REPELLING STATION
ST-02	CONSTRUCTION OF BAKERY WITH WATER REPELLING STATION
ST-03	CONSTRUCTION OF BAKERY WITH WATER REPELLING STATION
ST-04	CONSTRUCTION OF BAKERY WITH WATER REPELLING STATION
ST-05	CONSTRUCTION OF BAKERY WITH WATER REPELLING STATION
ST-06	CONSTRUCTION OF BAKERY WITH WATER REPELLING STATION
ST-07	CONSTRUCTION OF BAKERY WITH WATER REPELLING STATION
ST-08	CONSTRUCTION OF BAKERY WITH WATER REPELLING STATION
ST-09	CONSTRUCTION OF BAKERY WITH WATER REPELLING STATION
ST-10	CONSTRUCTION OF BAKERY WITH WATER REPELLING STATION
EL-01	CONSTRUCTION OF BAKERY WITH WATER REPELLING STATION
EL-02	CONSTRUCTION OF BAKERY WITH WATER REPELLING STATION
AD-03	CONSTRUCTION OF BAKERY WITH WATER REPELLING STATION
PL-01	CONSTRUCTION OF BAKERY WITH WATER REPELLING STATION
PL-02	CONSTRUCTION OF BAKERY WITH WATER REPELLING STATION
PL-03	CONSTRUCTION OF BAKERY WITH WATER REPELLING STATION
PL-04	CONSTRUCTION OF BAKERY WITH WATER REPELLING STATION
PL-05	CONSTRUCTION OF BAKERY WITH WATER REPELLING STATION
PL-06	CONSTRUCTION OF BAKERY WITH WATER REPELLING STATION

CONSTRUCTION OF BAKERY WITH WATER REPELLING STATION
SITE DEVELOPMENT PLAN



CONSTRUCTION OF BAKERY WITH WATER REPELLING STATION
VICINITY MAP



ADMINISTRATIVE SERVICE / DIVISION
FIELD OFFICE IX
BORDAS-AG-01-REV 02 (A)

CONSTRUCTION OF BAKERY WITH WATER REPELLING STATION

PROJECT OFFICER:
REY BERRY ANAPITAO, POLARIS, ZAMBANGA DEL NORTE

DESIGNED BY:
REY BERRY ANAPITAO

CHECKED BY:
MARICORIN M. MORALES

APPROVED BY:
LINDARD V. NITCH, RCM

DATE:
02/25/20

SCALE:
AS SHOWN

DATE OF ISSUE:
02/25/20

DATE OF REVISION:
02/25/20

DATE OF APPROVAL:
02/25/20

AR-01 02 / 25 20 X 30

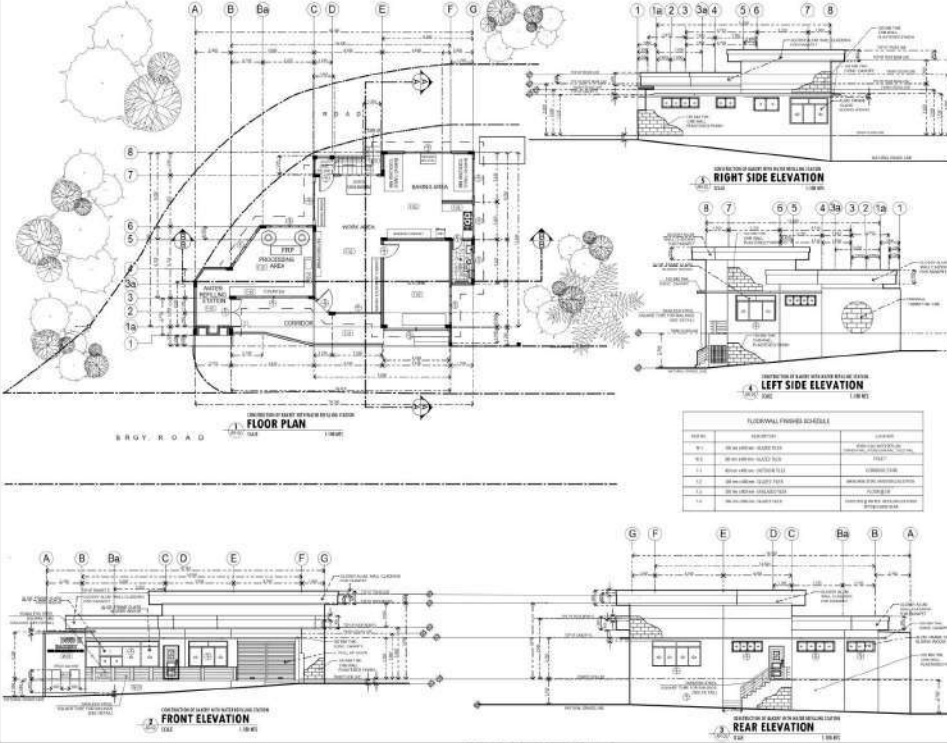

FLOOR PLAN

RIGHT SIDE ELEVATION

LEFT SIDE ELEVATION

FRONT ELEVATION

REAR ELEVATION

NO.	DESCRIPTION	QUANTITY	UNIT	REMARKS
01	CONCRETE	100	M ³	
02	STEEL	50	KG	
03	BRICK	200	M ²	
04	ROOFING	100	M ²	
05	PAINT	50	L	
06	GLASS	10	M ²	
07	DOOR	5	NO.	
08	WINDOW	10	NO.	
09	ROOFING	100	M ²	
10	PAINT	50	L	
11	GLASS	10	M ²	
12	DOOR	5	NO.	
13	WINDOW	10	NO.	
14	ROOFING	100	M ²	
15	PAINT	50	L	
16	GLASS	10	M ²	
17	DOOR	5	NO.	
18	WINDOW	10	NO.	

ADMINISTRATIVE SERVICE / DIVISION
FIELD OFFICE IX
BORDAS-AG-01-REV 02 (A)

CONSTRUCTION OF BAKERY WITH WATER REPELLING STATION

PROJECT OFFICER:
REY BERRY ANAPITAO, POLARIS, ZAMBANGA DEL NORTE

DESIGNED BY:
REY BERRY ANAPITAO

CHECKED BY:
MARICORIN M. MORALES

APPROVED BY:
LINDARD V. NITCH, RCM

DATE:
02/25/20

SCALE:
AS SHOWN

DATE OF ISSUE:
02/25/20

DATE OF REVISION:
02/25/20

DATE OF APPROVAL:
02/25/20

AR-02 03 / 25 20 X 30

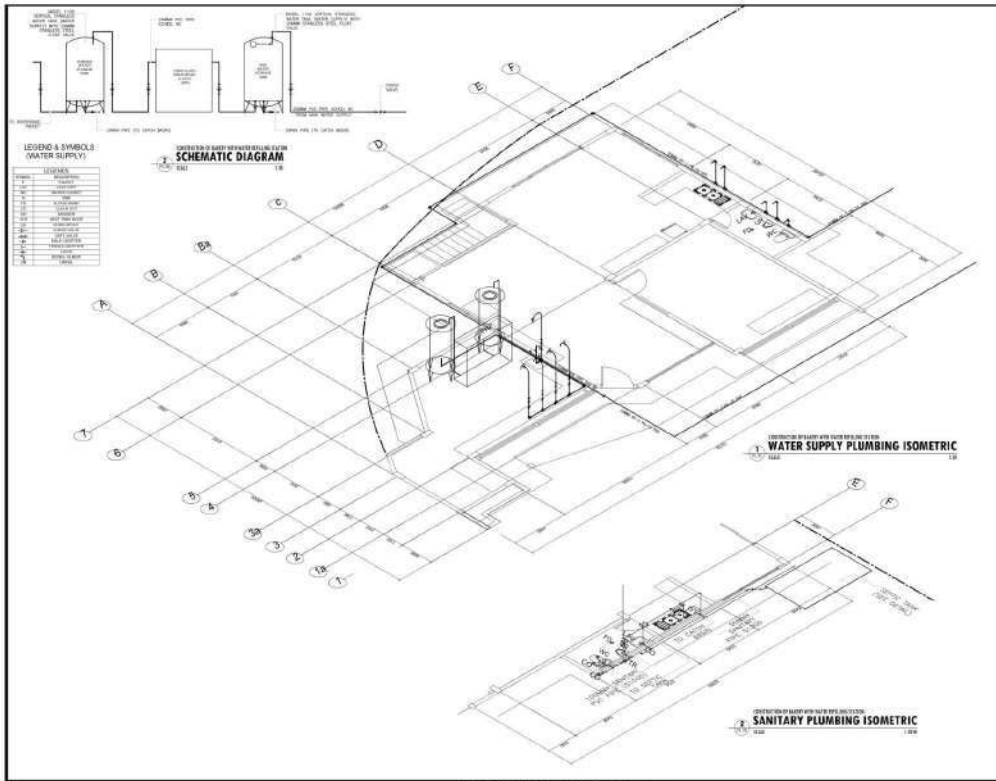

DSWD Department of Social Welfare and Development		
ADMINISTRATIVE SERVICE / DIVISION FIELD OFFICE IX DSWD-ASO-F OIX (REV 01) 01-001		
PROJECT NAME CONSTRUCTION OF BAKERY WITH WATER REFILLING STATION		
PROJECT LOCATION BROY ANASTACIO, PULACOL, DABONGKANG DEL NORTE		
DESIGNER MARILYN P. RAMOS/CE/CE/IV REGISTERED		
CHECKER MR. JOSEPH S. MENDOZA, RUP REGISTERED		
APPROVER LORIANE M. VELAZQUEZ, RUP REGISTERED		
REVISIONS		
NO. OF SHEETS 22 / 25		
DATE 2023-05-25		
SCALE AS SHOWN		
SHEET NO. PL - 03		
TOTAL SHEETS 25		
PROJECT NO. 20 X 30		

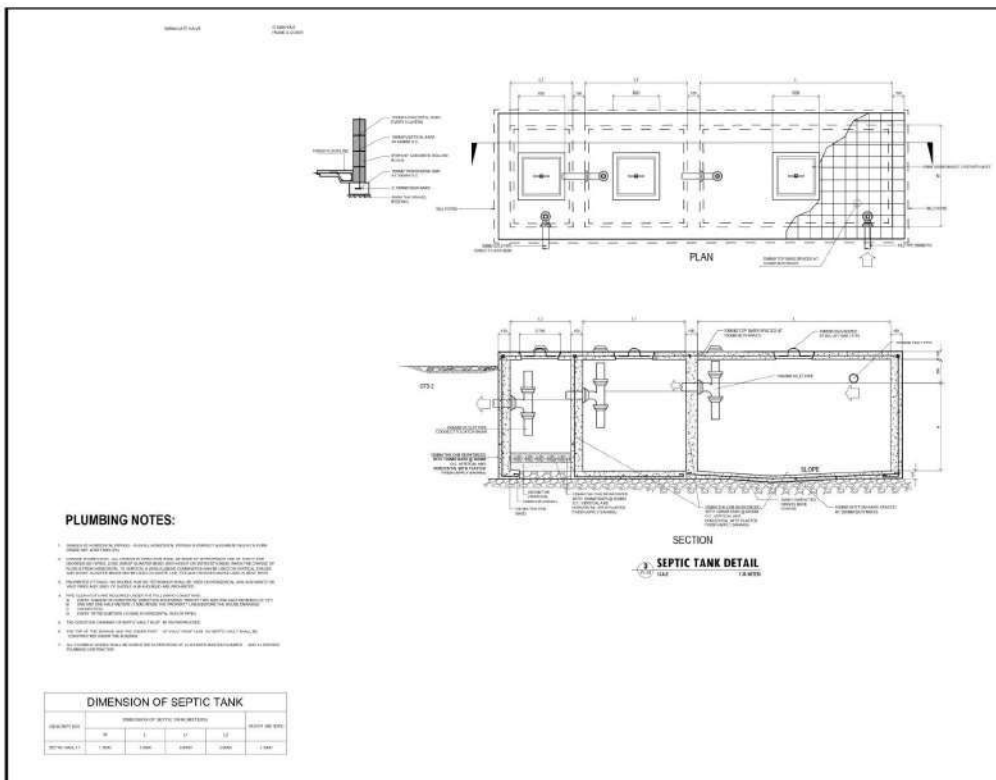

DSWD Department of Social Welfare and Development		
ADMINISTRATIVE SERVICE / DIVISION FIELD OFFICE IX DSWD-ASO-F OIX (REV 01) 01-001		
PROJECT NAME CONSTRUCTION OF BAKERY WITH WATER REFILLING STATION		
PROJECT LOCATION BROY ANASTACIO, PULACOL, DABONGKANG DEL NORTE		
DESIGNER MARILYN P. RAMOS/CE/CE/IV REGISTERED		
CHECKER MR. JOSEPH S. MENDOZA, RUP REGISTERED		
APPROVER LORIANE M. VELAZQUEZ, RUP REGISTERED		
REVISIONS		
NO. OF SHEETS 23 / 25		
DATE 2023-05-25		
SCALE AS SHOWN		
SHEET NO. PL - 04		
TOTAL SHEETS 25		
PROJECT NO. 20 X 30		

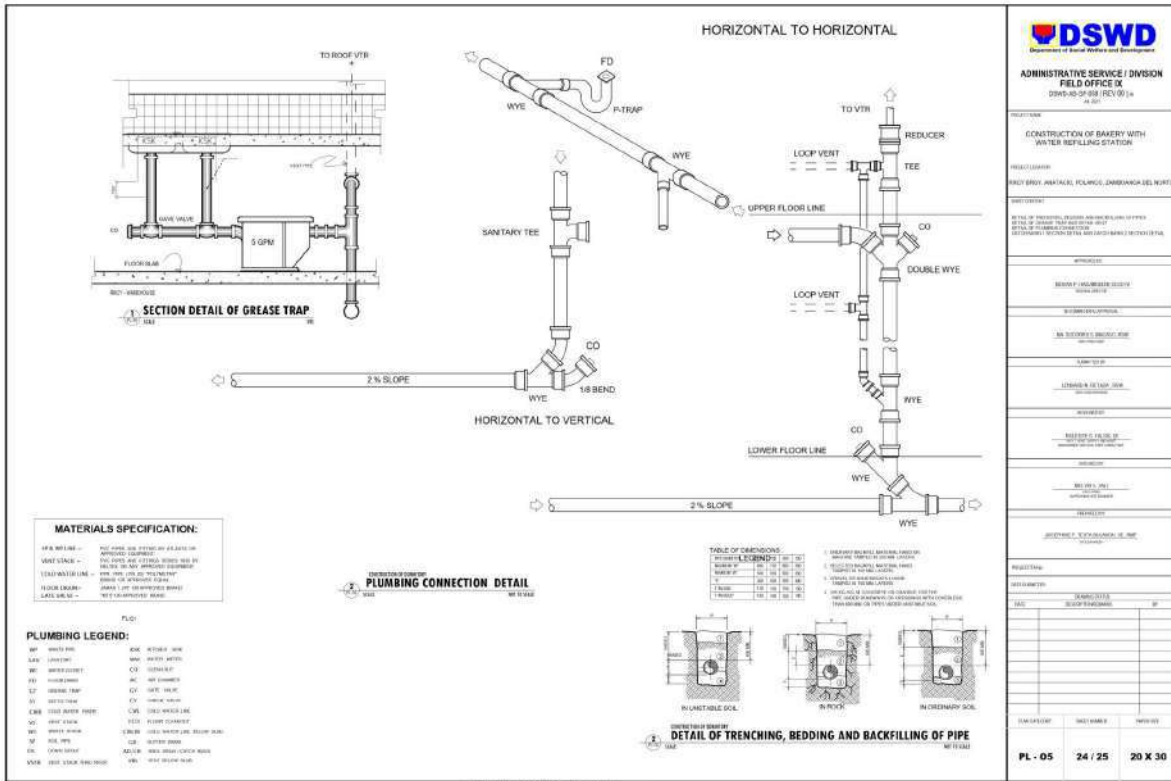

DSWD
Department of Social Welfare and Development

ADMINISTRATIVE SERVICE / DIVISION
FIELD OFFICE IX
DSWD-AS-SP-008 (REV 01) 4

PROJECT NAME:
CONSTRUCTION OF BAKERY WITH WATER REFILLING STATION

PROJECT LOCATION:
BRGY. MANGALAN, PALABAN, DAVAO DEL NORTE

DATE:

SCALE:

PL - 05 24 / 25 20 X 30

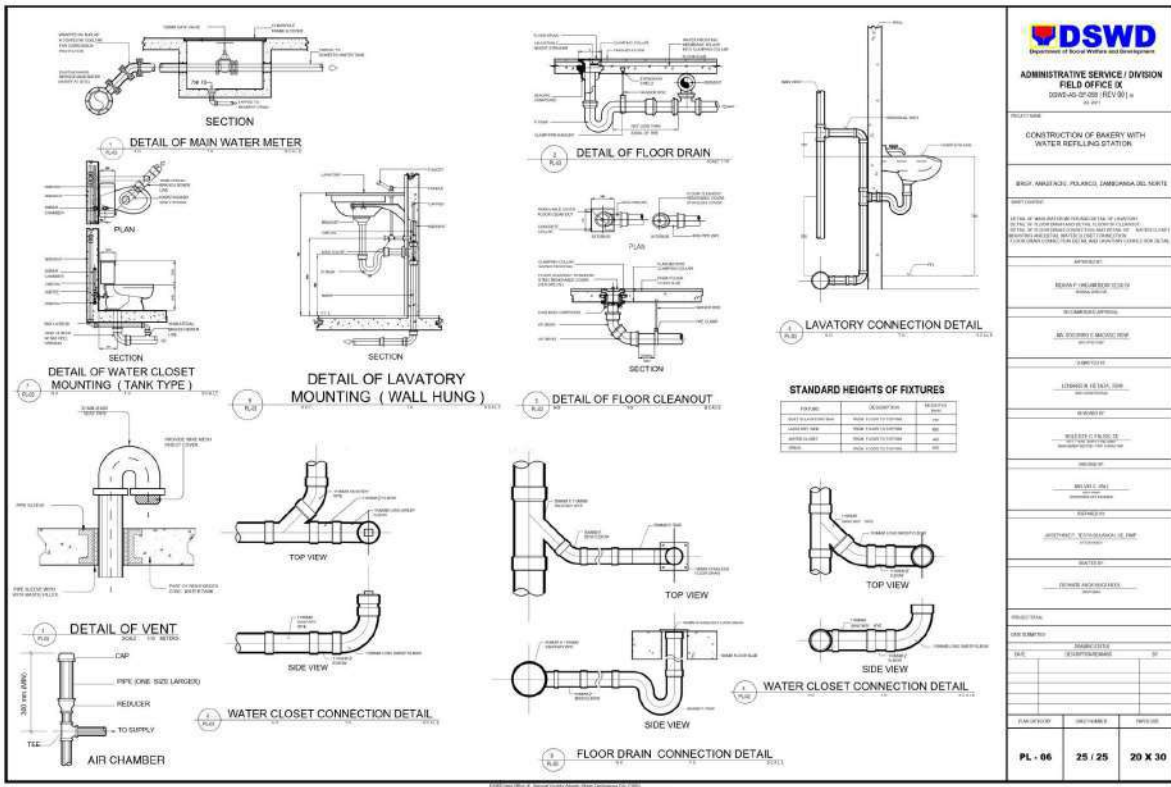

DSWD
Department of Social Welfare and Development

ADMINISTRATIVE SERVICE / DIVISION
FIELD OFFICE IX
DSWD-AS-SP-008 (REV 01) 4

PROJECT NAME:
CONSTRUCTION OF BAKERY WITH WATER REFILLING STATION

PROJECT LOCATION:
BRGY. MANGALAN, PALABAN, DAVAO DEL NORTE

DATE:

SCALE:

PL - 06 25 / 25 20 X 30

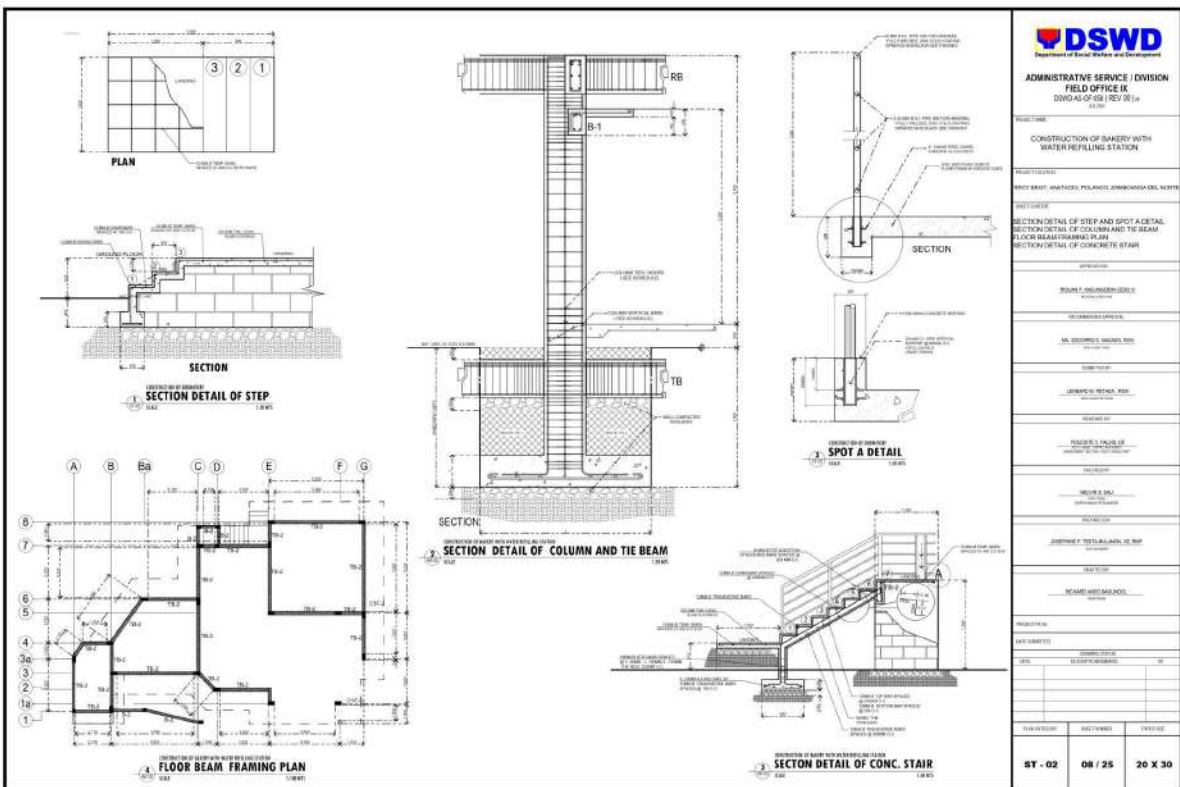
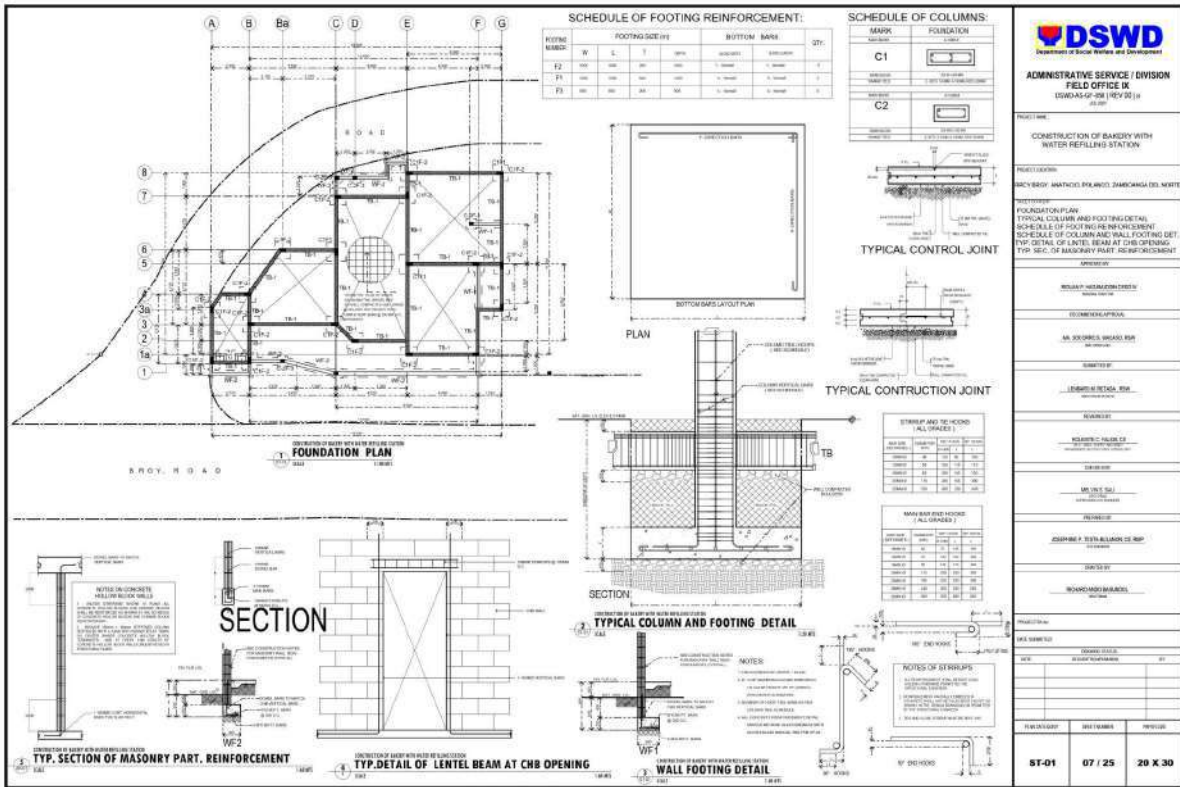

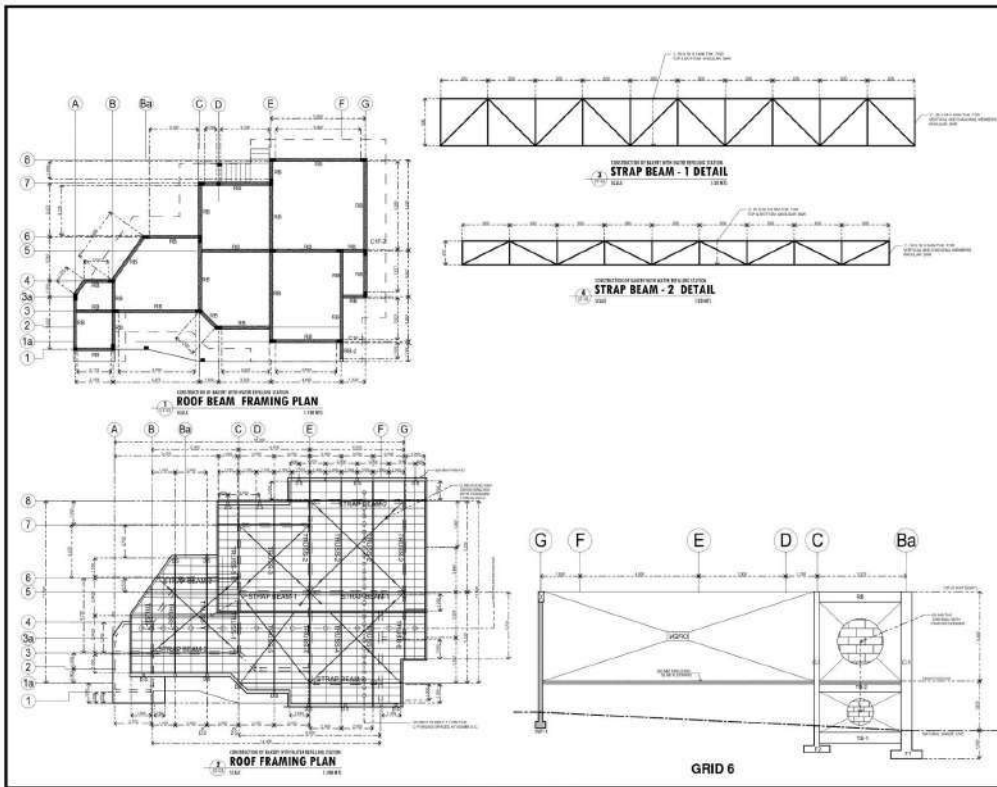

DSWD Department of Social Welfare and Development		
ADMINISTRATIVE SERVICE / DIVISION FIELD OFFICE K DSWDAS-OF-03 (REV 02) 01		
PROJECT NAME: CONSTRUCTION OF BANKERY WITH WATER RE-FILLING STATION		
PROJECT OFFICE: REC'D-BPOFF, ANTIPOLO, POLARIS COMMERCE DEL. NORTH		
DESIGN OFFICE: RUFFO BEAM FRAMING PLAN ROOF FRAMING PLAN STRAP BEAM 1 DETAIL AND STRAP BEAM 2		
APPROVED BY: [Signature]		
DESIGNED BY: [Signature]		
CHECKED BY: [Signature]		
DRAWN BY: [Signature]		
DATE: 09/25/20		
SCALE: AS SHOWN		
PROJECT NO. / SHEET NO. / TOTAL SHEETS: ST - 03 / 09 / 25 / 20 X 30		

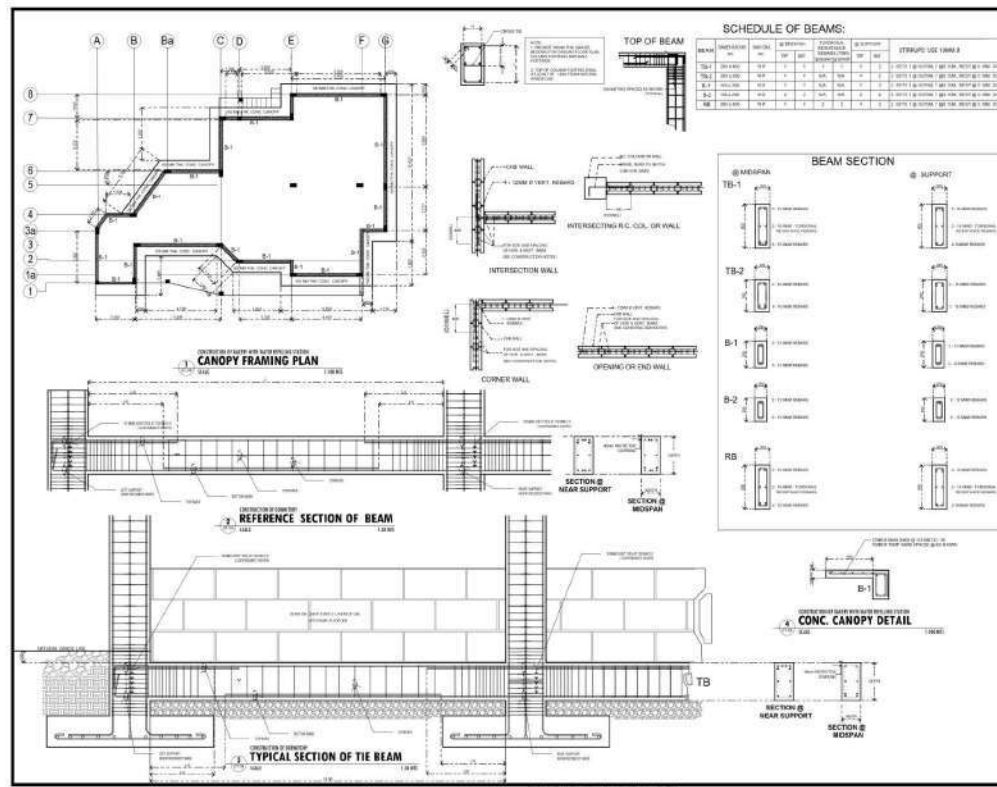

DSWD Department of Social Welfare and Development		
ADMINISTRATIVE SERVICE / DIVISION FIELD OFFICE K DSWDAS-OF-03 (REV 02) 01		
PROJECT NAME: CONSTRUCTION OF BANKERY WITH WATER RE-FILLING STATION		
PROJECT OFFICE: REC'D-BPOFF, ANTIPOLO, POLARIS COMMERCE DEL. NORTH		
DESIGN OFFICE: RUFFO BEAM FRAMING PLAN ROOF FRAMING PLAN STRAP BEAM 1 DETAIL AND STRAP BEAM 2		
APPROVED BY: [Signature]		
DESIGNED BY: [Signature]		
CHECKED BY: [Signature]		
DRAWN BY: [Signature]		
DATE: 10/25/20		
SCALE: AS SHOWN		
PROJECT NO. / SHEET NO. / TOTAL SHEETS: ST - 04 / 10 / 25 / 20 X 30		

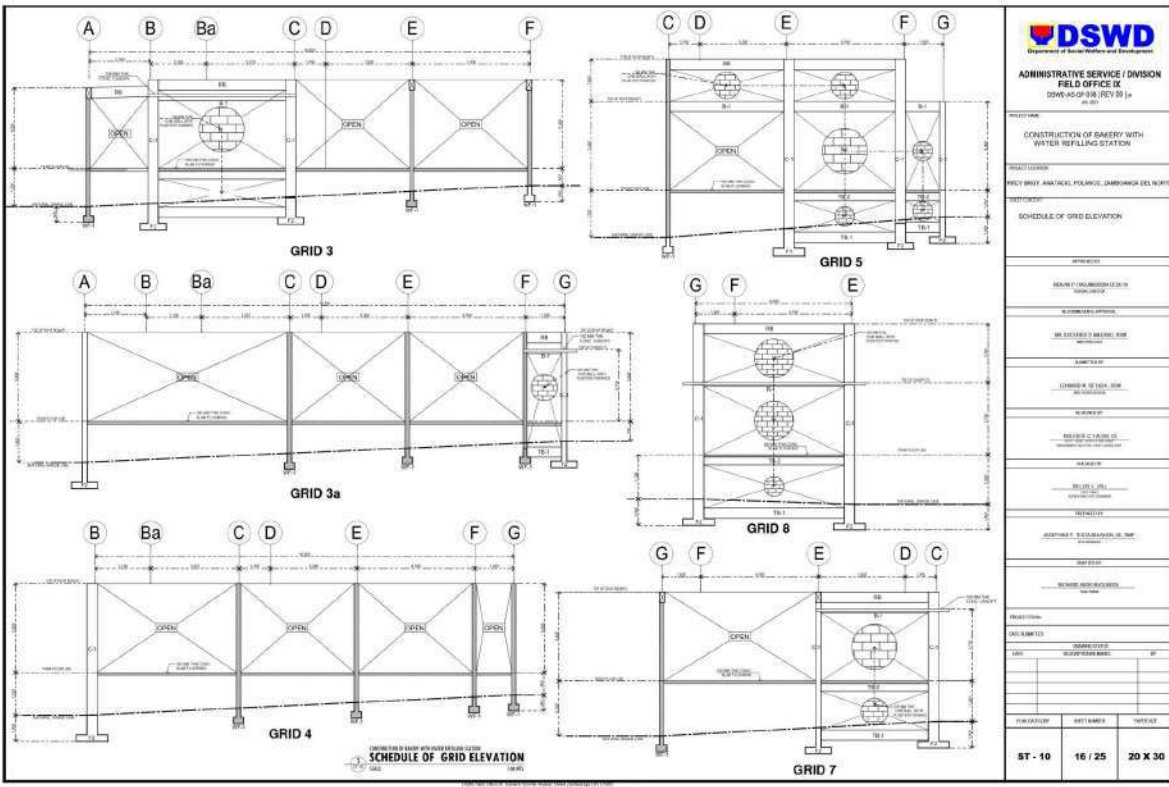
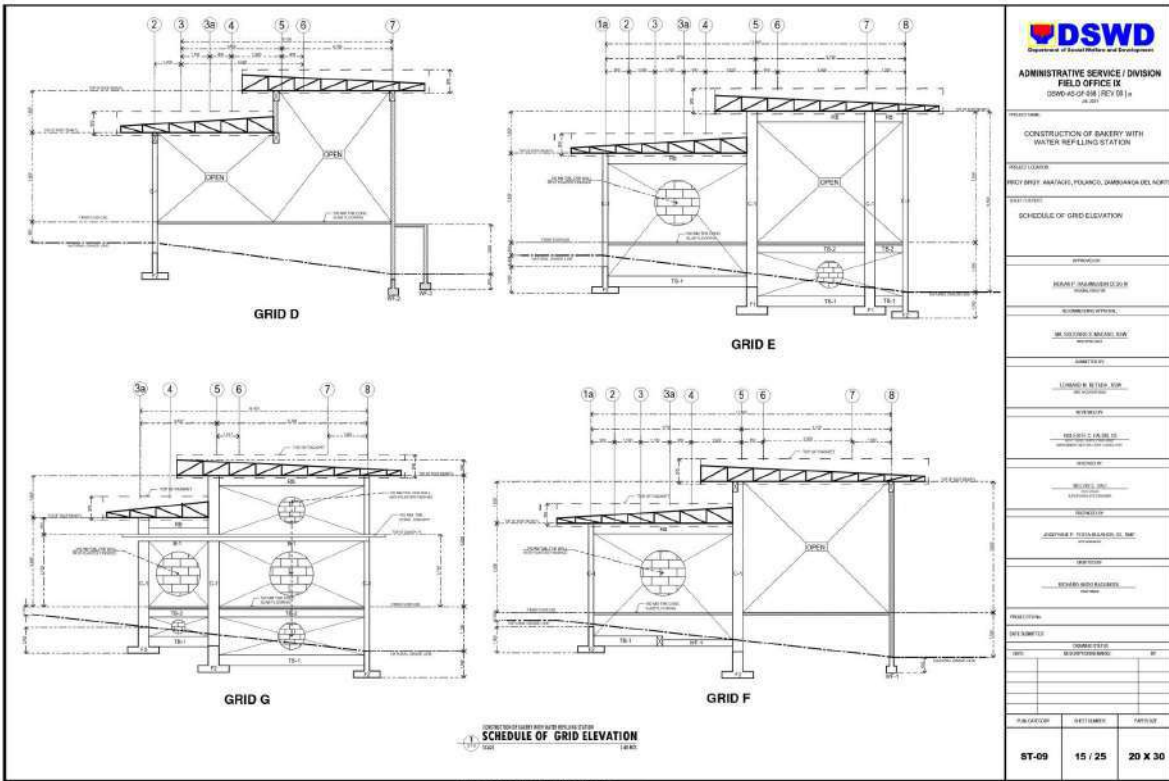

Section VIII. Bill of Quantities

Notes on the Bill of Quantities

Objectives

The objectives of the Bill of Quantities are:

- a. to provide sufficient information on the quantities of Works to be performed to enable Bids to be prepared efficiently and accurately; and
- b. when a Contract has been entered into, to provide a priced Bill of Quantities for use in the periodic valuation of Works executed.

In order to attain these objectives, Works should be itemized in the Bill of Quantities in sufficient detail to distinguish between the different classes of Works, or between Works of the same nature carried out in different locations or in other circumstances which may give rise to different considerations of cost. Consistent with these requirements, the layout and content of the Bill of Quantities should be as simple and brief as possible.

Daywork Schedule

A Daywork Schedule should be included only if the probability of unforeseen work, outside the items included in the Bill of Quantities, is high. To facilitate checking by the Entity of the realism of rates quoted by the Bidders, the Daywork Schedule should normally comprise the following:

- a. A list of the various classes of labor, materials, and Constructional Plant for which basic daywork rates or prices are to be inserted by the Bidder, together with a statement of the conditions under which the Contractor will be paid for work executed on a daywork basis.
- b. Nominal quantities for each item of Daywork, to be priced by each Bidder at Daywork rates as Bid. The rate to be entered by the Bidder against each basic Daywork item should include the Contractor's profit, overheads, supervision, and other charges.

Provisional Sums

A general provision for physical contingencies (quantity overruns) may be made by including a provisional sum in the Summary Bill of Quantities. Similarly, a contingency allowance for possible price increases should be provided as a provisional sum in the Summary Bill of Quantities. The inclusion of such provisional sums often facilitates budgetary approval by avoiding the need to request periodic supplementary approvals as the future need arises. Where such provisional sums or contingency allowances are used, the SCC should state the manner in which they will be used, and under whose authority (usually the Procuring Entity's Representative's).

The estimated cost of specialized work to be carried out, or of special goods to be supplied, by other contractors should be indicated in the relevant part of the Bill of Quantities as a particular provisional sum with an appropriate brief description. A separate procurement procedure is normally carried out by the Procuring Entity to select such specialized contractors. To provide an element of competition among the Bidders in respect of any facilities, amenities, attendance, etc., to be provided by the successful Bidder as prime Contractor for the use and convenience of the specialist contractors, each related provisional sum should be followed by an item in the Bill of Quantities inviting the Bidder to quote a sum for such amenities, facilities, attendance, etc.

Signature Box

A signature box shall be added at the bottom of each page of the Bill of Quantities where the authorized representative of the Bidder shall affix his signature. Failure of the authorized representative to sign each and every page of the Bill of Quantities shall be a cause for rejection of his bid.

These Notes for Preparing a Bill of Quantities are intended only as information for the Procuring Entity or the person drafting the Bidding Documents. They should not be included in the final documents.

PROGRAM OF WORKS

DRN:					
Name of Project:		Location:			
Construction of Skills Training Center for Bread and Pastries and Water Refilling Station		RRCY, Anastacio, Polanco, Zamboanga del Norte			
Total Project Cost:	PHP 5,669,161.58	Project Duration:	CD	154	
Source of Fund:	Capital Outlay	Mode of Procurement:	Competitive Bidding		
Date:	November 8, 2023	Source of Manpower:	Contractor		
Item No.		Quantity	Unit	Unit Cost	Amount
1	SITE WORKS	180.96	sq.m.		
2	REINFORCING STEELBARS	8148.88	kgs		
3	FORMWORKS AND SCAFFOLDINGS	4471.34	bd.ft		
4	CONCRETE WORKS	54.50	CU.M.		
5	MASONRY WORKS	367.14	sq.m.		
6	METAL WORKS	11469.88	Kgs.		
7	ROOFING WORKS	185.09	sq.m.		
8	CARPENTRY WORKS	247.96	sq.m.		
9	DOORS AND WINDOWS	50.75	sq.m.		
10	PLUMBING WORKS	14.00	DFU		
11	LABOR & MATERIALS FOR TRIPLE MEMBRANE WATER REFILLING PACKAGE	1.00	Lot		
12	TILE WORKS	218.97	sq.m.		
13	ELECTRICAL WORKS	1.00	lot		
14	AMENITIES	33.00	Units		
15	PAINTING WORKS	757.65	sq.m.		
16	SIGNAGES	2.00	lots		
17	CONSTRUCTION FOREMAN	122.00	Days		

PROGRAM OF WORKS

DRN:			
Name of Project:		Location:	
Construction of Skills Training Center for Bread and Pastries and Water Refilling Station		RRCY, Anastacio, Polanco, Zamboanga del Norte	
Total Project Cost:	PHP 5,669,161.58	Project Duration:	CD 154
Source of Fund:	Capital Outlay	Mode of Procurement:	Competitive Bidding
Date:	November 8, 2023	Source of Manpower:	Contractor
A	Total Direct Cost (Material, Labor and Equipment)		
B	OCM (10% of A)		
C	Contractor's Profit (8% of A)		
D	VAT (5% of A+B+C)		
E	Material Testing		
F	Health and Safety		
G	Permits and Clearances		
TOTAL PROJECT COST			PHP 5,669,161.58
GENERAL CONDITION AND REQUIREMENTS			
Adherence to building code, policies, construction safety and health, quality assurance and quality control, labor laws and other applicable conditions.		Equipments needed:	
		Welding Machine	
		Grinder	
		160 CFN Compressor & two (2) Jack Hammer	

BILL OF QUANTITIES

DRN: _____

Name of Project:	Construction of Skills Training Center for Bread and Pastries and Water Refilling Station	Location:	RRCY, Anastacio, Polanco, Zamboanga del Norte	
Total Project Cost:	PHP 5,669,161.58	Project Duration:	154.00	Calendar Days
Source of Fund:	Capital Outlay	Mode of Procurement:	Competitive Bidding	
Date:	November 8, 2023	Source of Manpower:	Contractor	

Item No.	Item Description	Quantity	Unit	Material Cost	Labor Cost	Equip't Cost	Fuel and Lubri	Unit Cost	Amount
1	SITE WORKS	180.96	sq.m.						568.61
1.1	Clearing & Layouting	180.96	sq.m.						
1.11	Coco Lumber	600.00	Bd. Ft.						
1.12	Nylon String No. 16	8.00	rolls						
1.13	3" CW Nails	10.00	Kgs.						
1.14	Carpentry	2.00	day/s						
1.15	Laborer	4.00	day/s						
1.2	Demolition of Existing Structure	9.53	cu.m.						
1.21	160 CFN Compressor & two (2) Jack Hammer	2.00	day/s						
1.22	Operator	2.00	Day/s						
1.23	Laborer	2.00	Day/s						
1.3	Structural Excavation	66.07	cu.m.						
1.31	Laborer	35.00	Day/s						
1.4	Embankment	125.58	cu.m.						
1.41	Embankment Materials	89.00	cu.m.						
1.42	Laborer	30.00	day/s						
1.5	Gravel Bedding	23.00	cu.m.						
1.51	Mixed and Washed Gravel	23.00	cu.m.						
1.52	Laborer	12.00	day/s						
SUB - TOTAL (SITE WORK)									
2	REINFORCING STEELBARS	8148.88	kgs						
2.1	10mm dia. x 6.0m std. def. bar	779.00	Lengths						
2.2	12mm dia. x 6.0m std. def. bar	164.00	Lengths						
2.3	16mm dia. x 6.0m std. def. bar	462.00	Lengths						
2.4	16mm dia. x 6.0m round bar	2.00	Lengths						
2.5	# 16 G.I. Tie Wire	180.00	Kgs.						
2.6	Steelman	105.00	day/s						
2.7	Laborer	105.00	day/s						
SUB - TOTAL (REINFORCING STEELBARS)									
3	FORMWORKS AND SCAFFOLDINGS	4471.3353	bd.ft						54.64

Item No.	Item Description	Quantity	Unit	Material Cost	Labor Cost	Equip't Cost	Fuel and Lubri	Unit Cost	Amount
3.1	2"x2"x10' Coco Lumber (two use)	1465.51	Bd.Ft						
3.2	2"x3"x12' Coco Lumber	3005.83	Bd.Ft						
3.3	1/2 thk. 4'x8' Ordinary Plywood (two use)	112.5	shts.						
3.4	4" CW Nails	15	Kgs.						
3.5	3" CW Nails	10	Kgs.						
3.6	1½" CW Nails	10	Kgs.						
3.7	Carpenter	72	day/s						
3.8	Laborer	72	day/s						
SUB - TOTAL (FORMWORKS AND SCAFF									
4	CONCRETE WORKS	54.50 C.U.M.							
4.1	Portland Cement	520	Bags						
4.2	Sahara Cement (SV slab)	7	packs						
4.3	Washed Sand	35	Cu. m.						
4.4	Washed Gravel (G-3/4)	60	Cu. m.						
4.5	Mason	22	Day/s						
4.6	Laborer	110	Day/s						
SUB - TOTAL (CONCRETE WORK									
5	MASONRY WORKS	367.14 sq.m.							
5.1	CHB LAYING	367.14 sq.m.							
5.11	Portland Cement	224.00	Bags						
5.12	Washed Sand	20.00	Cu.m.						
5.13	4" x 8" x 16" Concrete Hollow Block	4,552.00	Pcs.						
5.14	6" x 8" x 16" Concrete Hollow Block	267.00	Pcs.						
5.15	10mmØ Reinforcing Steel Bars	283.00	Length						
5.16	# 16 G.I. Tie Wire	12.00	Kgs.						
5.16	Mason	38.00	day/s						
5.17	Laborer	76.00	day/s						
5.2	PLASTERING	628.35 sq.m.							
5.21	Portland Cement	238.00	bags						
5.22	Washed Sand	12.00	Cu. m.						
5.23	Sahara Cement	4.00	bags						
5.24	Mason	56.00	Day/s						
5.25	Laborer	56.00	Day/s						
SUB - TOTAL (MASONRY WORK									

Item No.	Item Description	Quantity	Unit	Material Cost	Labor Cost	Equip't Cost	Fuel and Lubri	Unit Cost	Amount
6	METALWORKS	11469.88 Kgs.			80.39				
	6.1 Roof Framing Works	7247.411	kgs						
	6.11 5mm x 50mm x 50mm x Angle Bar	174	Lengths						
	6.12 5mm x 38mm x 38mm x Angle Bar	153	Lengths						
	6.13 5mm thk Steel Plate	16.18	sq.m.						
	6.14 12mm thk Steel Plate	2.1521	sq.m.						
	6.15 12mmØ A307 x 400mm Anchor Bolt	88	pcs						
	6.16 Welding Electrodes (2.5kg)	20	boxes						
	6.17 Grinding Disc	35	pcs						
	6.18 Cutting Disc	18	pcs						
	6.19 Red Oxide Metal Primer	15	gal						
	6.20 2" Paint Brush	10	pcs						
	6.21 Steelman	60	Day/s						
	6.22 Laborer	60	Day/s						
	6.23 Welding Machine	20	Day/s						
	6.2 C-Purlins Installation	794.1408	kgs						
	6.21 1.2mm x 50mmx75mm C-purlins (standard)	64	Lengths						
	6.22 5mm x 50mm x 50mm x Angle Bar	3	Lengths						
	6.23 12mm dia. x 6.0m round bar	40	Lengths						
	6.24 Standard Tum Buckle	20	pcs						
	6.25 Welding Electrodes (2.5kg)	10	boxes						
	6.26 Red Oxide Metal Primer	5	gal						
	6.27 2" Paint Brush	12	pcs						
	6.28 Grinding Disc	20	pcs						
	6.29 Cutting Disc	5	pcs						
	6.30 Steelman	8	day/s						
	6.31 Laborer	8	day/s						
	6.32 Equipment	4	day/s						

Item No.	Item Description	Quantity	Unit	Material Cost	Labor Cost	Equip't Cost	Fuel and Lubri	Unit Cost	Amount
6.3	Parapet Frame Holder	2092.938	kgs.						
6.31	5mm x 50mm x 50mm x Angle Bar	84	Lengths						
6.32	5mm x 38mm x 38mm x Angle Bar	14	Lengths						
6.33	Welding Electrodes (2.5kg)	20	boxes						
6.34	Grinding Disc	35	pcs						
6.35	Cutting Disc	18	pcs						
6.36	Red Oxide Metal Primer	15	gal						
6.37	2" Paint Brush	10	pcs						
6.38	Steelman	42	day/s						
6.39	Laborer	42	day/s						
6.40	Equipment	14	day/s						
6.4	Fascia Framing Works	486.642	kgs.						
6.41	5mm x 25mm x 25mm x Angle Bar	28	Lengths						
6.42	4mm x 25mm Flat Bar	7	Lengths						
6.43	Red Oxide Metal Primer	3	gal						
6.44	2" Paint Brush	10	pcs						
6.45	Welding Electrodes (2.5kg)	6	boxes						
6.46	Grinding Disc	10	pcs						
6.47	Steelman	12	day/s						
6.48	Laborer	12	day/s						
6.49	Equipment	12	day/s						
6.5	Stainless Railing Works	57.658	In.m.						
6.51	50mm x 100mm Stainless Steel Rec. Tube	1	Lengths						
6.52	50mmx75mm Stainless Steel Rectangular Tube	4	Lengths						
6.53	50mmx50mm Stainless Steel Square Tube	2	Lengths						
6.54	25mmx25mm Stainless Steel Square Tube	4	Lengths						
6.55	12mmØ Stainless Steel Pipe	1	Lengths						
6.56	Welding Electrodes Stainless (2.5kg)	3	boxes						
6.57	Grinding Disc	10	pcs						
6.58	297g Rubbing Compound (Heavy Duty)	2	pcs						
6.59	Steelman	10	day/s						
6.60	Laborer	10	day/s						
6.61	Welding Machine	10	day/s						

Item No.	Item Description	Quantity	Unit	Material Cost	Labor Cost	Equip't Cost	Fuel and Lubri	Unit Cost	Amount
6.6	Window Grills	848.74413	kgs.						
6.61	12mm x 12mm Square Bar	125.1835	lengths						
6.62	Welding Rod (2.5kgs)	10	boxes						
6.63	Grinding Disc	20	pcs						
6.64	Steelman	11.00	day/s						
6.65	Laborer	22.00	day/s						
6.66	Welding Machine	11	day/s						
SUB - TOTAL (METALWORKS)									
7	ROOFING WORKS	185.09	sq.m.						
7.1	Roof Covering	185.09	sq.m.						
7.11	0.40mm Rib type (Pre-painted Red) Colorroof	185.09	ln.m.						
7.12	Teckscrew 2" (Stæel)	3,479.00	pcs.						
7.13	3/16" Steel Drill Bit (Dorco)	12.00	pcs.						
7.14	0.5 liter Roof Sealant	10.00	pcs						
7.15	Steelman	10.00	day/s						
7.16	Laborer	10.00	day/s						
7.2	Installation of Fascia Cap	33.19	ln.m						
7.21	Bended Acc./Fascia Cap- 0.40mm x 24" x 8' (Pre Fab./Pre-Painted Red)	14.00	lengths						
7.22	1/8" Ø x 1/2" blind rivets	2.00	boxes						
7.23	3/16" Steel Drill Bit (Dorco)	3.00	pcs						
7.24	Steelman	5.00	day/s						
7.25	Laborer	5.00	day/s						
7.3	Installation of Flashing	90.19	ln.m.						
7.31	Bended Acc./Wall Flashing - 0.40mm x 24" x 8' (Pre Fab./Pre-Painted Red)	38.00	lengths						
7.32	1/8" Ø x 1/2" blind rivets	3.00	boxes						
7.33	3/16" Steel Drill Bit (Dorco)	3.00	pcs.						
7.34	Steelman	8.00	day/s						
7.35	Laborer	8.00	day/s						
7.4	Installation of Gutter	33.19	ln.m						
7.41	Bended Acc./Gutter - 0.40mm x 24" x 8' (Pre Fab./Pre-Painted Red)	14.00	lengths						
7.42	1/8" Ø x 1/2" blind rivets	2.00	boxes						
7.43	3/16" Steel Drill Bit (Dorco)	3.00	pcs.						
7.44	Steelman	5.00	day/s						
7.45	Laborer	5.00	day/s						

Item No.	Item Description	Quantity	Unit	Material Cost	Labor Cost	Equip't Cost	Fuel and Lubri	Unit Cost	Amount
7.5	Installation of Aluminum Cladding	75.27	sq.m.						
7.51	6mm thk Glossy Aluminum Cladding (4'x8')	27.00	sheets						
7.52	1/8" Ø x 1/2" blind rivets.	5.00	boxes						
7.53	3/16" Steel Drill Bit (Dorco)	5.00	pcs						
7.54	Steelman	8.00	day/s						
7.55	Laborer	8.00	day/s						
SUB - TOTAL (ROOFING WORK)									
8	CARPENTRY WORKS	247.96	sq.m.						
8.1	Ceiling Frame	616.80	ln.m.						
8.11	0.5mm thk Double Metal Furring	51.00	lengths						
8.12	0.8mm thk Carrying Channel	54.00	lengths						
8.13	0.5mm thk Wall Angle	20.00	lengths						
8.14	Blind Rivets 1/8x3/4	6.00	boxes						
8.15	Concrete Nails 1"	4.00	kgs						
8.16	Carpenter	8.00	day/s						
8.17	Laborer	16.00	day/s						
8.2	Ceiling Board - Marine Plywood	129.30	sq.m.						
8.21	1/2" thk Marine Plywood	45.00	sheets						
8.22	Blind Rivets 1/8x3/4	4.00	boxes						
8.23	Carpenter	10.00	Day/s						
8.24	Laborer	20.00	Day/s						
8.3	Ceiling Board - Spandrel	118.66	sq.m.						
8.31	0.4mm thk Pre-painted Spandrel	239.00	ln.m.						
8.32	0.4mm thk Pre-Painted Wall Angle	30.00	lengths						
8.33	Blind Rivets 1/8x3/4	4.00	boxes						
8.34	Carpenter	4.00	Day/s						
8.35	Laborer	8.00	Day/s						
SUB - TOTAL (CARPENTRY WORKS)									

Item No.	Item Description	Quantity	Unit	Material Cost	Labor Cost	Equip't Cost	Fuel and Lubri	Unit Cost	Amount	
9	DOORS AND WINDOWS	50.75 sq.m.							3,704.80	
9.1	Door Works	18.53 sq.m.								
9.11	1.80m X 2.10m Double Swing Door on Aluminum Frame with 3/16 thk Glass	1.00	set							
9.12	0.90m x 2.10m Solid Panel Door with Viewing Glass (paint finished) ready to install	3.00	sets							
9.12	2.36m X 3.40m Roll Up Door	1.00	set							
9.13	0.60m X 2.10m PVC Door	1.00	ase							
9.14	410mm x 700mm Cabinet Door	8.00	-							
9.15	Concealed Hinge	8.00	pairs							
9.16	Cabinet Door Handle	8.00	pcs							
9.17	Cabinet Door Catch Latch	8.00	pcs							
9.18	Carpenter	6.00	day/s							
9.19	Laborer	12.00	day/s							
9.2	Window Works	32.22 sq.m.								
9.21	4.85m x 1.70m Combination of Fixed Glass & Sliding Window on Powder Coated Aluminum Frame with Screen	1.00	set							
9.22	3.2M X 1.50M Glass Window, Powder Coated Aluminum Frame with Screen	1.00	set							
9.23	2.4M X 1.5M Sliding Window Glass , Powder Coated Aluminum Frame with Screen	3.00	sets							
9.24	2.4M X 0.6M Sliding Window Glass , Powder Coated Aluminum Frame with Screen	4.00	sets							
9.25	2.1M X 0.90M Sliding Window Glass , Powder Coated Aluminum Frame with Screen	1.00	set							
9.26	1.20M X 0.60M Sliding Window Glass , Powder Coated Aluminum Frame with Screen	1.00	set							
9.27	Carpenter	12.00	Day/s							
9.28	Laborer	24.00	Day/s							
SUB - TOTAL (DOORS AND WINI										

Item No.	Item Description	Quantity	Unit	Material Cost	Labor Cost	Equip't Cost	Fuel and Lubri	Unit Cost	Amount
10	PLUMBING WORKS	14.00 DFU			8,552.23				
10.10	Plumbing Fixtures Installation	14.00 DFU							
10.11	White Ceramic Water Closet	1.00	set						
10.12	Lavatory with complete Accessories & fittings (Hang Type)	1.00	set						
10.13	Urinal	1.00	set						
10.14	4x4 floor drain (Stainless)	1.00	pc						
10.15	Bidet Shower Complete Set (Stainless)	1.00	pcs						
10.16	Brass Faucet	1.00	pcs						
10.17	Plumber/ Mason	4.00	Day/s						
10.18	Laborer	4.00	Day/s						
10.2	Materials for House Drain	14.32 In.m.							
10.21	4"Ø x 3.0m PVC Sanitary Pipe S-1000	5.00	Lengths						
10.22	4"Ø Sanitary Wye, PVC	1.00	Pc.						
10.23	4"Ø x 90° long sweep elbow, PVC	3.00	Pcs.						
10.24	4"Ø Sanitary Tee, PVC	4.00	Pcs.						
10.25	4"Ø x 1/8 bend elbow, PVC	1.00	pcs.						
10.26	4"Ø sanitary clean out cover, PVC	5.00	Pcs.						
10.27	4"Ø PVC Coupling	2.51	Pcs.						
10.28	4"Ø x 2"Ø Reducer Tee PVC	2.00	Pcs.						
10.29	2"Ø PVC P-trap	1.00	Pcs.						
10.30	500ml PVC Cement	2.00	cans						
10.31	Plumber	3.00	Day/s						
10.32	Laborer	3.00	Day/s						
10.3	Waste & Vent Pipe Installation	27.67 In.m.							
10.31	3"Ø x 3.0m PVC Sanitary Pipe S-1000	10.00	lengths						
10.32	3"Ø x 90° Elbow, PVC	10.00	pcs.						
10.33	3"Ø Tee, PVC	8.00	pcs						
10.34	500ml PVC Cement	2.00	can						
10.35	Plumber	2.00	Day/s						
10.36	Laborer	2.00	Day/s						

Item No.	Item Description	Quantity	Unit	Material Cost	Labor Cost	Equip't Cost	Fuel and Lubri	Unit Cost	Amount
10.4	Water Supply Line Installation	43.27	In.m.						
10.41	25mmØ x 2.3mm x 4m PP-R Pipe PN20	10.00	Lengths						
10.42	20mmØ x 2.3mm x 4m PP-R Pipe PN20	2.00	Lengths						
10.43	25mmØ PP-R Plain Tee	3.00	Pcs.						
10.44	25mmØ PP-R Reducer	3.00	Pcs.						
10.45	25mmØ PP-R coupling	17.00	Pcs.						
10.46	20mmØ PP-R 90° Elbow	5.00	Pcs.						
10.47	20mmØ PP-R Female Elbow with Brass Thread	2.00	Pcs.						
10.48	20mmØ PP-R Angle Valve	1.00	Pcs.						
10.48	20mmØ Brass Water Faucet	2.00	Pcs.						
10.50	ppr pipe heater-Fashion Machine with Mould size 20mm 25mm 32mm	1.00	unit	1					
10.51	Teflon Tape, 25mm (tombo)	4.00	Rolls						
10.52	500ml PVC Cement	2.00	can						
10.53	Plumber	4.00	Day/s						
10.54	Laborer	4.00	Day/s						
10.5	Materials for Storm Drain	123.59	In.m.						
10.51	3"Ø x 3.0m PVC Sanitary Pipe S-1000	42.00	lengths						
10.52	3"Ø x 45° Elbow, PVC	24.00	pcs.						
10.53	3"Ø x 90° Elbow, PVC	4.00	pcs.						
10.54	500ml PVC Cement	2.00	cans						
10.55	Plumber	11.00	Day/s						
10.56	Laborer	11.00	Day/s						
10.6	Materials for LPG Supply Line	7.00	In.m.						
10.57	25mmØ GI Pipe Sched. 40	2.00	lengths						
10.52	25mmØ GI Elbow Sched. 40	10.00	pcs.						
10.53	25mmØ Ball Valve Brass	2.00	pcs.						
10.54	1/2 x 3/8 Hose Connector	2.00	pcs.						
10.55	Pigtail LPG Hose	7.00	meters						
10.56	Teflon Tape	4.00	pcs.						
10.55	Plumber	1.00	Day/s						
10.56	Laborer	1.00	Day/s						
10.7	Materials for Range Hood	2.00	units						
10.71	125mmØ Aluminum Powder Coated Air Vent	2.00	pcs.						
10.72	125mmØ x 2.5m Flexible Duct	2.00	lengths						
10.73	90 cm x 300watts dual motor power	2.00	units	6					
10.74	Plumber	2.00	Day/s						
10.75	Laborer	2.00	Day/s						
SUB - TOTAL (PLUMBING WORK)									

Item No.	Item Description	Quantity	Unit	Material Cost	Labor Cost	Equip't Cost	Fuel and Lubri	Unit Cost	Amount
11	Labor and Materials for Triple Membrane Water Refilling Package	1.00 Lot			385,000.00				
11.1	1. Fiber Glass Reinforced Plastic (FRP)	3.00	sets						
11.2	2. Big Blue Filter	20.00	sets						
11.3	3. Reverse Osmosis Pump	1.00	unit						
11.4	4. Feed Pump with Automatic Pump Control	1.00	unit						
11.5	5. Dispensing pump with American Pump Control	2.00	unit						
11.6	6. Full monitoring Indicator's Alarm	1.00	unit						
11.7	7. 1000L Stainless Tank (Raw Tank)	1.00	tank						
11.8	8. 1000L Stainless Tank (Storage Tank)	1.00	tank						
11.9	9. Brine Tank	1.00	tank						
12	10. 6 gpm UV Set	1.00	set						
12.1	11. water vendo	2.00	units						
12.2	12. heat gun	1.00	unit						
12.2	13. palstic seals	4.00	packs						
12.3	14. dispensing faucet	3.00	pcs.						
12.4	15. marketing assistance training	1.00	training						
12.5	16. operation and maintenance training	2.00	training						
SUB - TOTAL (Labor and Materials for Triple Membrane Water Refilling Package)									
11	TILEWORKS	218.97 sq.m.			1,494.73				
11.1	0.60m x 0.60m Unglazed Tiles	23.00	pcs						
11.2	0.30m x 0.60m Unglazed Tiles	23.00	pcs						
11.3	0.40m x 0.40m Clazed Tiles	824.00	pcs						
11.4	0.30m x 0.60m Clazed Tiles	261.00	pcs						
11.5	0.40m x 0.40m Outdoor Tiles	247.00	pcs						
11.6	Portland Cement	96.00	bags						
11.7	Washed Sand	9.00	cu.m.						
11.8	Tile Adhesive (20 kgs)	43.00	bags						
11.9	Tile Grout	34.00	packs						
12	8' Tile Trim, Plastic	12.00	lengths						
12.1	8' Tile Trim, Metallic	4.00	lengths						
12.2	8' Stair Nosing Gold	6.00	lengths						
12.2	Tiler (600mm x 600mm)	2.00	Day/s						
12.3	Laborer	4.00	Day/s						
12.4	Tiler (400mm x 400mm)	28.00	day/s						
12.5	Laborer	56.00	day/s						
12.6	Tiler (200mm x 300mm)	7.00	day/s						
12.7	Laborer	14.00	day/s						
SUB - TOTAL (TILEWORKS)									

Item No.	Item Description	Quantity	Unit	Material Cost	Labor Cost	Equip't Cost	Fuel and Lubri	Unit Cost	Amount
12	ELECTRICAL WORKS	1.00 lot			186,720.00				
12.10	Interior Rough in	58.00 utility boxes							
12.11	2" x 4" Utility Boxes Pvc	58.00	pcs.						
12.12	250mm x 250mm Pull Box Metal Prepainted	2.00	pcs.						
12.13	1" dia. RSC Pipe	1.00	length						
12.14	20mmØ Electrical PVC Pipe Sched 40	80.00	lengths						
12.15	Screw Insulator	2.00	pcs.						
12.16	Electrician	14.00	Day/s						
12.17	Laborer	28.00	Day/s						
12.20	Electrical Wires	1.00 lot							
12.21	3.5mm ² THHN Stranded	3.00	boxes						
12.22	2.0mm ² THHN Stranded	4.00	boxes						
12.23	PVC Clip comp. w/ nails	1,000.00	Pcs.						
12.24	Electrical Tape (Big)	12.00	Pcs.						
12.25	Electrician	40.00	Day/s						
12.26	Laborer	80.00	Day/s						
12.30	Electrical Fixtures	12427.00 watts							
12.31	9 Watts Led Downlight (round Type)	43.00	sets						
12.32	3 Gang 3 prong Convenience Outlet	26.00	sets						
12.33	2 Gang 3 prong Ceiling Fan Outlet	5.00	sets						
12.34	2 Gang 3 prong Hand Dryer Outlet	2.00	sets						
12.35	1 Gang Convenience Outlet for Emergency Lights	10.00	sets						
12.36	3 Gang Flush type Switch w/ Plate	13.00	sets						
12.37	2 Gang Flush type Switch w/ Plate	1.00	sets						
12.38	1 Gang Flush type Switch w/ Plate	1.00	sets						
12.39	100 Amp, 2P, MCCB	1.00	set						
12.40	60 Amp Circuit Breaker	1.00	pcs.						

Item No.	Item Description	Quantity	Unit	Material Cost	Labor Cost	Equip't Cost	Fuel and Lubri	Unit Cost	Amount
	12.41 40 Amp Circuit Breaker	1.00	pcs.						
	12.42 30 Amp Circuit Breaker	3.00	pcs.						
	12.43 20 Amp Circuit Breaker	5.00	pcs.						
	12.44 15 Amp Circuit Breaker	3.00	pcs.						
	12.45 Entrance Cap # 1" dia.	2.00	Pcs.						
	12.46 Electrician	28.00	Day/s						
	12.47 Laborer	28.00	Day/s						
SUB - TOTAL (ELECTRICAL WORK)									
13	AMENITIES	33.00 Units							
	13.10 Hand Dryer, hot and cold wind, wall mounted, 5-20 sec. drying time, made of ABS plastic, touch free infrared sensor, power input 1800W	2.00	units						
	13.20 20" Industrial Wall Fan	10.00	units						
	13.30 Exhaust Fan (see attached plan details)	2.00	units						
	13.40 Rack Stack (see attached plan details)	2.00	units						
	13.50 Stainless Steel Table (see attached plan details)	2.00	units						
	13.60 Twin head LED Emergency Light	10.00	units						
	13.70 600mm x 1800mm X 3/16 Mirror with Aluminum Frame	2.00	units						
	13.80 200mmx250mmx500mm Portable Fire Extinguisher Box	3.00	units						
	13.90 Installer	5.00	Day/s						
	14.00 Laborer	5.00	Day/s						
SUB - TOTAL (AMENITIES)									

Item No.	Item Description	Quantity	Unit	Material Cost	Labor Cost	Equip't Cost	Fuel and Lubri	Unit Cost	Amount
14	PAINTING WORKS	757.65 sq.m.			273.96				
14.1	Neutralizer Application	628.35 sq.m.							
	14.11 Neutraliser	16.00	gal						
	14.12 Roller Brush	2.00	pcs						
	14.13 Painter	8.00	day/s						
	14.14 Laborer	8.00	day/s						
14.2	Masonry Surface Smoothing	628.35 sq.m.							
	14.21 Skim Coat	67.00	bags						
	14.22 Sand Paper #100	4.00	doz						
	14.23 Painter	18.00	Day/s						
	14.24 Laborer	18.00	Day/s						
14.3	Masonry Painting	628.35 sq.m.							
	14.31 Flat Latex White	5.00	pails						
	14.32 Gloss Latex White	10.00	pails						
	14.33 Paint Roller	4.00	pcs						
	14.34 2" Paint Brush	4.00	pcs						
	14.35 Sand Paper #100 (3M)	314.17	sheets						
	14.36 Sand Paper #80	157.09	doz						
	14.37 Carpenter	18.00	Day/s						
	14.38 Laborer	18.00	Day/s						
14.4	Plywood Ceiling Smoothing	5.00 sq.m.							
	14.41 Fiber Glass Mesh Tape (50mm x 250 ft)	2.00	pcs						
	14.42 Epoxy	4.00	cans						
	0.01 Glazing Putty	22.00	gal						
	0.02 Putty Knife	6.00	pcs						
	0.01 Sand Paper #100 (3m)	64.65	sheet						
	0.02 Sand Paper #80 (3m)	32.33	sheet						
	14.43 Painter	9.00	Day/s						
	14.44 Laborer	9.00	Day/s						
14.5	Plywood Ceiling Painting	5.03 sq.m.							
	14.51 Flat Enamel White	6.00	gals						
	14.52 Gloss Latex White	13.92	gals						
	14.53 Paint Roller	5.00	pcs						
	14.54 2" Paint Brush	10.00	pcs						
	14.55 Sand Paper #100 (3m)	21.55	sheet						
	14.56 Sand Paper #80 (3m)	10.78	sheet						
	14.57 Carpenter	6.00	Day/s						
	14.58 Laborer	6.00	Day/s						

Item No.	Item Description	Quantity	Unit	Material Cost	Labor Cost	Equip't Cost	Fuel and Lubri	Unit Cost	Amount
14.0	Metal Surface Painting	100.73	In.m.						
14.01	Red Oxide Primer Paint	8.00	gals						
0.01	Quick Dry Enamel Paint-Black	2.00	gals						
0.01	Paint Thinner	4.00	gal						
0.01	2" Paint Brush	10.00	pcs						
0.01	Painter	1.00	Day/s						
0.01	Laborer	4.00	Day/s						
SUB - TOTAL (PAINTING WORK)									
16	SIGNAGES	2.00	lots						
16.1	Panaflex and Stainless Steel Built Letters	1.00	lot						
16.11	0.6M X 0.7M Panaflex with Backlight	1.00	sets						1
16.12	35cm High Stainless Steel Built Up Letters	4.00	letters						
16.13	32cm x 22cm x 3cm Stainless Steel Built Up Letters	8.00	letters						
16.14	18cm x 11cm x 3cm Stainless Steel Built Up Letters	38.00	letters						
16.15	Artist	2.00	Day/s						
16.16	Laborer	2.00	Day/s						
16.2	Tarpauline	2.88	sq.m.						
16.21	4'X8' Tarpauline	1.00	sheet						
16.22	6'-x2'-x10' Mahogany Lumber	10.00	bd.ft.						
16.23	3" Common Wire Nail	0.50	kg						
16.24	1" Common Wire Nail	0.50	kg						
16.25	Artist	1.00	Day/s						
16.26	Laborer	1.00	Day/s						
SUB - TOTAL (SIGNAGES)									

Item No.	Item Description	Quantity	Unit	Material Cost	Labor Cost	Equip't Cost	Fuel and Lubri	Unit Cost	Amount
17	CONSTRUCTION FOREMAN	122.00 Days						700.00	
17.1	Construction Foreman	122.00	Days	-	700.00				
SUB - TOTAL (CONSTRUCTION FOREMAN)									
A	Total Direct Cost (Material, Labor and Equipment)								
B	OCM (10% of A)								
C	Contractor's Profit (8% of A)								
D	VAT (5% of A+B+C)								
F	Material Testing								
G	Health & Safety								
H	Permits and Clearances								
TOTAL PROJECT COST								PHP	5,669,161.58

Prepared by:

Reviewed and Checked by:

Noted by:

Section IX. Checklist of Technical and Financial Documents

Notes on the Checklist of Technical and Financial Documents

The prescribed documents in the checklist are mandatory to be submitted in the Bid, but shall be subject to the following:

- a. GPPB Resolution No. 09-2020 on the efficient procurement measures during a State of Calamity or other similar issuances that shall allow the use of alternate documents in lieu of the mandated requirements; or
- b. any subsequent GPPB issuances adjusting the documentary requirements after the effectivity of the adoption of the PBDs.

The BAC shall be checking the submitted documents of each Bidder against this checklist to ascertain if they are all present, using a non-discretionary “pass/fail” criterion pursuant to Section 30 of the 2016 revised IRR of RA No. 9184.

Checklist of Technical and Financial Documents

I. TECHNICAL COMPONENT ENVELOPE	
<i>Class “A” Documents</i>	
<u>Legal Documents</u>	
<input type="checkbox"/>	(a) Valid PhilGEPS Registration Certificate (Platinum Membership) (all pages) in accordance with Section 8.5.2 of the IRR;
<u>Technical Documents</u>	
<input type="checkbox"/>	(b) Statement of the prospective bidder of all its ongoing government and private contracts, including contracts awarded but not yet started, if any, whether similar or not similar in nature and complexity to the contract to be bid; and
<input type="checkbox"/>	(c) Statement of the bidder’s Single Largest Completed Contract (SLCC) similar to the contract to be bid, except under conditions provided under the rules; and
<input type="checkbox"/>	(d) Special PCAB License in case of Joint Ventures and registration for the type and cost of the contract to be bid; and
<input type="checkbox"/>	(e) Original copy of Bid Security. If in the form of a Surety Bond, submit also a certification issued by the Insurance Commission or original copy of Notarized Bid Securing Declaration; and
<input type="checkbox"/>	(f) Project Requirements, which shall include the following:
<input type="checkbox"/>	a. Organizational chart for the contract to be bid;
<input type="checkbox"/>	b. List of contractor’s key personnel (e.g., Project Manager, Project Engineers, Materials Engineers, and Foremen), to be assigned to the contract to be bid, with their complete qualification and experience data;
<input type="checkbox"/>	c. List of contractor’s major equipment units, which are owned, leased, and/or under purchase agreements, supported by proof of ownership or certification of availability of equipment from the equipment lessor/vendor for the duration of the project, as the case may be; and
<input type="checkbox"/>	(g) Original duly signed Omnibus Sworn Statement (OSS) and if applicable, Original Notarized Secretary’s Certificate in case of a corporation, partnership, or cooperative; or Original Special Power of Attorney of all members of the joint venture giving full power and authority to its officer to sign the OSS and do acts to represent the Bidder.
<u>Financial Documents</u>	
<input type="checkbox"/>	(h) The prospective bidder’s computation of Net Financial Contracting Capacity (NFCC).

<i>Class "B" Documents</i>	
<input type="checkbox"/>	(i) If applicable, duly signed joint venture agreement (JVA) in accordance with RA No. 4566 and its IRR in case the joint venture is already in existence or duly notarized statements from all the potential joint venture partners stating that they will enter into and abide by the provisions of the JVA in the instance that the bid is successful.
II. FIN.ANCIAL COMPONENT ENVELOPE	
<input type="checkbox"/>	(j) Original of duly signed and accomplished Financial Bid Form; and
<i>Other documentary requirements under RA No. 9184</i>	
<input type="checkbox"/>	(k) Original of duly signed Bid Prices in the Bill of Quantities; and
<input type="checkbox"/>	(l) Duly accomplished Detailed Estimates Form, including a summary sheet indicating the unit prices of construction materials, labor rates, and equipment rentals used in coming up with the Bid; and
<input type="checkbox"/>	(m) Cash Flow by Quarter.

